



SAFETY MANUAL

SIL 3 Switch/Proximity Detector Repeater Transistor Open Collector Output, DIN-Rail and Termination Board, Models D6031S, D6031D

Reference must be made to the relevant sections within the instruction manual ISM0214,
which contain basic guides for the installation of the equipment.



Application for D6031D (used as double channel, with independent channels)

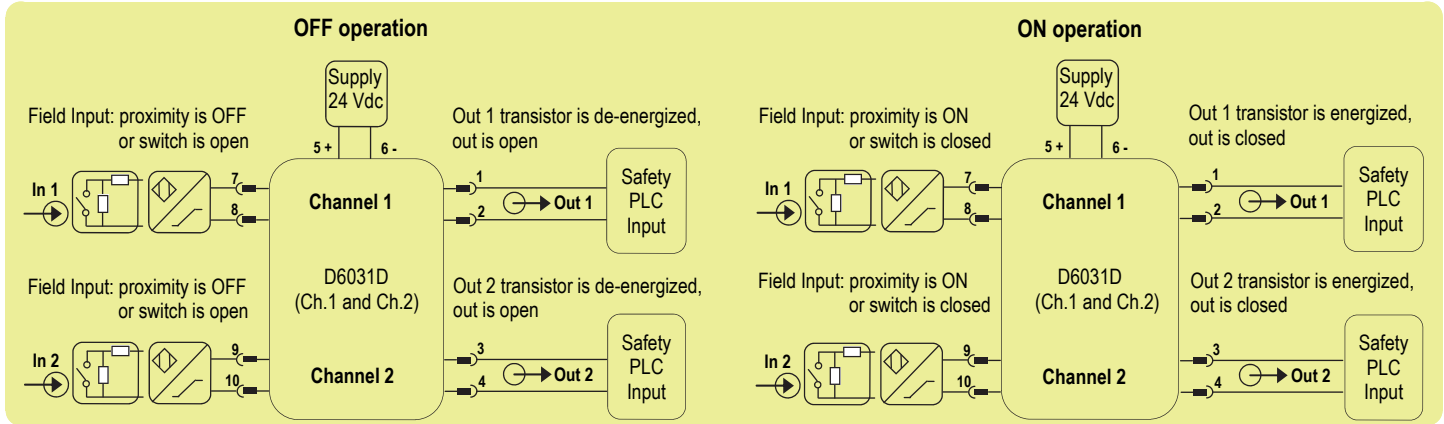

Description:

For this application, enable input line fault (open or short) detection and direct input to output transfer function, by set the internal dip-switches in the following mode (see pages 7 and 8 for more information):

Dip-switch position	1	2	3	4	5	6	7	8
ON/OFF state	ON	OFF	ON	OFF	ON	OFF	OFF	OFF

The module is powered by connecting 24 Vdc power supply to Pins 5 (+ positive) - 6 (- negative). The green LED is lit in presence of supply power.

Input signals from field are applied to Pins 7-8 (In 1 - Ch.1) and Pins 9-10 (In 2 - Ch.2).

Transistor outputs Pins 1-2 (for Channel 1) and Pins 3-4 (for Channel 2) are both normally open (or transistor de-energized as safe state condition) for OFF operation, while they are both closed (or transistor energized) for ON operation.

The following table describes for each channel the state (open or closed) of its output when its input signal is in OFF or ON state, and it gives information about turn-on or turn-off of the related channel status LED and channel fault LED:

Input signal state Pins 7-8 (In 1 - Ch.1) or 9-10 (In 2 - Ch.2)	Transistor output state Pins 1-2 (Out 1 - Ch.1) or 3-4 (Out 2 - Ch.2)	Channel status yellow LED state	Channel fault red LED state
Proximity sensor is OFF or switch is open	Open (De-energize transistor)	OFF	OFF
Proximity sensor is ON or switch is closed	Closed (Energized transistor)	ON	OFF
Independently from proximity sensor or switch state, the input line is break	Open (De-energized transistor as safe state condition)	OFF	ON
Independently from proximity sensor or switch state, the input line is in short circuit	Open (De-energized transistor as safe state condition)	OFF	ON

Safety Function and Failure behavior:

D6031D is considered to be operating in Low Demand mode, as a Type A module, having Hardware Fault Tolerance (HFT) = 0.

The failure behaviour is described from the following definitions :

- fail-Safe State: it is defined as the transistor output is open;
- fail Safe: failure mode that causes the module to go to the defined fail-safe state without a demand from the process;
- fail Dangerous: failure mode that does not respond to a demand from the process (i.e. being unable to go to the defined fail-safe state), so that the transistor output remains closed;
- fail "No Effect": failure mode of a component that plays a part in implementing the safety function but that is neither a safe failure or a dangerous failure.
When calculating the SFF this failure mode is not taken into account;
- fail "Not part": failure mode of a component which is not part of the safety function but part of the circuit diagram and is listed for completeness.
When calculating the SFF this failure mode is not taken into account. It is also not considered for the total failure rate (safety function) evaluation.

The 2 channels of D6031D module could be used to increase the hardware fault tolerance, needed for a higher SIL of a certain Safety Function, as they are completely independent each other, not containing common components. In fact, the analysis results got for D6031S (single channel) are also valid for each channel of D6031D (double channel).

Failure rate date: taken from Siemens Standard SN29500.

Failure rate table:

Failure category	Failure rates (FIT)
λ_{dd} = Total Dangerous Detected failures	0.00
λ_{du} = Total Dangerous Undetected failures	11.20
λ_{sd} = Total Safe Detected failures	0.00
λ_{su} = Total Safe Undetected failures	117.46
$\lambda_{tot\ safe}$ = Total Failure Rate (Safety Function) = $\lambda_{dd} + \lambda_{du} + \lambda_{sd} + \lambda_{su}$	128.66
MTBF (safety function, one channel) = $(1 / \lambda_{tot\ safe}) + MTTR$ (8 hours)	887 years
$\lambda_{no\ effect}$ = "No Effect" failures	214.34
$\lambda_{not\ part}$ = "Not Part" failures	0.20
$\lambda_{tot\ device}$ = Total Failure Rate (Device) = $\lambda_{tot\ safe} + \lambda_{no\ effect} + \lambda_{not\ part}$	343.20
MTBF (device, one channel) = $(1 / \lambda_{tot\ device}) + MTTR$ (8 hours)	332 years

Failure rates table according to IEC 61508:2010 Ed.2 :

λ_{sd}	λ_{su}	λ_{dd}	λ_{du}	SFF
0.00 FIT	117.46 FIT	0.00 FIT	11.20 FIT	91.29%

PFDavg vs T[Proof] table (assuming Proof Test coverage of 99%), with determination of SIL supposing module contributes ≤10% of total SIF dangerous failures:

T[Proof] = 1 year	T[Proof] = 2 years	T[Proof] = 20 years
PFDavg = 4.91 E-05 Valid for SIL 3	PFDavg = 9.82 E-05 Valid for SIL 3	PFDavg = 9.82 E-04 Valid for SIL 2

PFDavg vs T[Proof] table (assuming Proof Test coverage of 99%), with determination of SIL supposing module contributes >10% of total SIF dangerous failures:

T[Proof] = 10 years
PFDavg = 4.91 E-04 Valid for SIL 3

Systematic capability SIL 3.

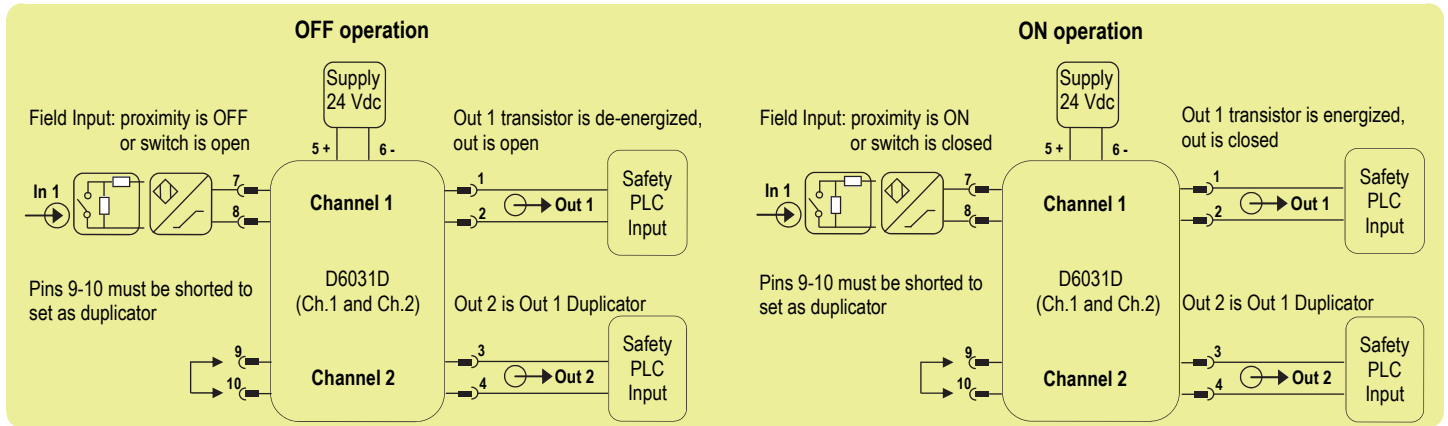

Description:

To enable input line fault (open or short) detection on In 1, direct input to output transfer and Out 1 Duplicator functionality (with Parallel mode) on channel 2, set the internal dip-switches in the following mode (see pages 7 and 9 for more information).

Dip-switch position	1	2	3	4	5	6	7	8
ON/OFF state	ON	OFF	OFF	OFF	ON	ON	OFF	ON

The module is powered by connecting 24 Vdc power supply to Pins 5 (+ positive) - 6 (- negative). The green LED is lit in presence of supply power.

Input signal from field is only applied to Pins 7-8 (In 1 - Ch.1). Pins 9-10 must be shorted to set the module as duplicator.

Transistor output Pins 1-2 (for Ch.1) and Pins 3-4 (for Ch.2) are normally open (or de-energized transistor as safe state condition) for OFF operation, while they are closed (or energized transistor) for ON operation.

The following table describes for Ch.1 and Ch.2 the output state (open or closed) when Ch.1 input signal is in OFF or ON state, and it gives information about turn-on or turn-off of channel status LED and channel fault LED:

Input 1 signal state Pins 7-8 (In 1 - Ch.1)	Out 1 transistor state Pins 1-2 (Out 1 - Ch.1)	Out 2 transistor state Pins 3-4 (Out 1 Duplicator)	Ch.1 or Ch.2 status yellow LED state	Ch.1 or Ch.2 fault red LED state
Proximity is OFF or switch is open	Open (De-energize transistor)	Open (De-energize transistor)	OFF	OFF
Proximity is ON or switch is closed	Closed (Energized transistor)	Closed (Energized transistor)	ON	OFF
If the input line is break	Open (safe state condition)	Open (safe state condition)	OFF	ON
If the input line is in short circuit	Open (safe state condition)	Open (safe state condition)	OFF	ON

Safety Function and Failure behavior:

D6031D is considered to be operating in Low Demand mode, as a Type A module, having Hardware Fault Tolerance (HFT) = 0.

The failure behaviour is described from the following definitions :

- fail-Safe State: it is defined as the transistor output is open;
- fail Safe: failure mode that causes the module to go to the defined fail-safe state without a demand from the process;
- fail Dangerous: failure mode that does not respond to a demand from the process (i.e. being unable to go to the defined fail-safe state), so that the transistor output remains closed;
- fail "No Effect": failure mode of a component that plays a part in implementing the safety but that is neither a safe failure or a dangerous failure.
When calculating the SFF this failure mode is not taken into account;
- fail "Not part": failure mode of a component which is not part of the safety function but part of the circuit diagram and is listed for completeness.
When calculating the SFF this failure mode is not taken into account. It is also not considered for the total failure rate (safety function) evaluation.

Both channels Ch.1 and Ch.2 (as Ch.1 duplicator) are functional safety related.

Failure rate date: taken from Siemens Standard SN29500.

Failure rate table:

Failure category	Failure rates (FIT)
λ_{dd} = Total Dangerous Detected failures	0.00
λ_{du} = Total Dangerous Undetected failures	11.28
λ_{sd} = Total Safe Detected failures	0.00
λ_{su} = Total Safe Undetected failures	169.79
$\lambda_{tot\ safe}$ = Total Failure Rate (Safety Function) = $\lambda_{dd} + \lambda_{du} + \lambda_{sd} + \lambda_{su}$	181.07
MTBF (safety function, for each channel) = $(1 / \lambda_{tot\ safe}) + MTTR$ (8 hours)	630 years
$\lambda_{no\ effect}$ = "No Effect" failures	409.53
$\lambda_{not\ part}$ = "Not Part" failures	93.20
$\lambda_{tot\ device}$ = Total Failure Rate (Device) = $\lambda_{tot\ safe} + \lambda_{no\ effect} + \lambda_{not\ part}$	683.80
MTBF (device) = $(1 / \lambda_{tot\ device}) + MTTR$ (8 hours)	166 years

Failure rates table according to IEC 61508:2010 Ed.2 :

λ_{sd}	λ_{su}	λ_{dd}	λ_{du}	SFF
0.00 FIT	169.79 FIT	0.00 FIT	11.28 FIT	93.77%

PFDavg vs T[Proof] table (assuming Proof Test coverage of 99%), with determination of SIL supposing module contributes ≤10% of total SIF dangerous failures:

T[Proof] = 1 year	T[Proof] = 2 years	T[Proof] = 20 years
PFDavg = 4.95 E-05 Valid for SIL 3	PFDavg = 9.90 E-05 Valid for SIL 3	PFDavg = 9.90 E-04 Valid for SIL 2

PFDavg vs T[Proof] table (assuming Proof Test coverage of 99%), with determination of SIL supposing module contributes >10% of total SIF dangerous failures:

T[Proof] = 10 years
PFDavg = 4.95 E-04 Valid for SIL 3

Systematic capability SIL 3.

Application for D6031D (used as fault indicator)

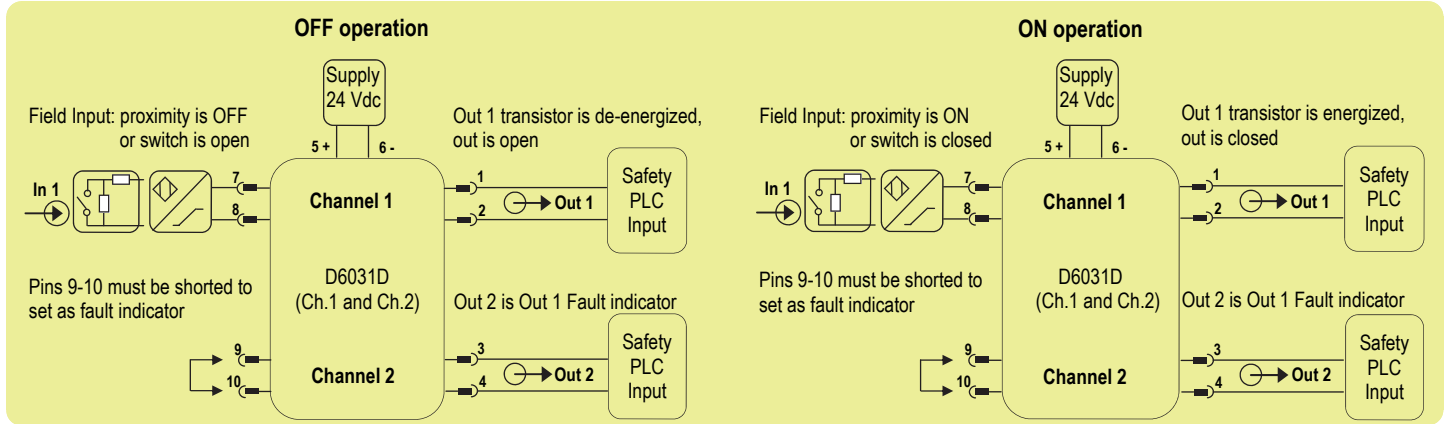

Description:

To enable input line fault (open or short) detection on In 1, direct input to output transfer and Out 1 Fault indicator functionality (with NE mode), set the internal dip-switches in the following mode (see pages 7 and 9 for more information).

Dip-switch position	1	2	3	4	5	6	7	8
ON/OFF state	ON	OFF	OFF	OFF	ON	OFF	ON	OFF

The module is powered by connecting 24 Vdc power supply to Pins 5 (+ positive) - 6 (- negative). The green LED is lit in presence of supply power.

Input signal from field is only applied to Pins 7-8 (In 1 - Ch.1). Pins 9-10 must be shorted to set the module as fault indicator.

Transistor output Pins 1-2 (for Ch.1) and Pins 3-4 (for Ch.2) are normally open (or de-energized transistor as safe state condition) for OFF operation, while they are closed (or energized transistor) for ON operation. Transistor output Pins 3-4 (for Ch.2) is related to Ch.1 Fault condition: without fault Out 2 is closed (or energized transistor); in case of fault Out 2 is open (or de-energized transistor as safe state condition). The following table describes for Ch.1 and Ch.2 the output state (open or closed) when Ch.1 input signal is in OFF or ON state, and it gives information about turn-on or turn-off

Input 1 signal state Pins 7-8 (In 1 - Ch.1)	Out 1 transistor state Pins 1-2 (Out 1 - Ch.1)	Out 2 transistor state Pins 3-4 (Out 1 Fault indicator)	Ch.1 status yellow LED state	Ch.1 fault red LED state	Ch.2 status yellow LED state
Proximity is OFF or switch is open	Open (De-energize transistor)	Closed (Energized transistor)	OFF	OFF	ON
Proximity is ON or switch is closed	Closed (Energized transistor)	Closed (Energized transistor)	ON	OFF	ON
If the input line is break	Open (safe state condition)	Open (safe state condition)	OFF	ON	OFF
If the input line is in short circuit	Open (safe state condition)	Open (safe state condition)	OFF	ON	OFF

Safety Function and Failure behavior:

D6031D is considered to be operating in Low Demand mode, as a Type A module, having Hardware Fault Tolerance (HFT) = 0.

The failure behaviour is described from the following definitions :

- fail-Safe State: it is defined as the transistor output is open;
- fail Safe: failure mode that causes the module to go to the defined fail-safe state without a demand from the process;
- fail Dangerous: failure mode that does not respond to a demand from the process (i.e. being unable to go to the defined fail-safe state), so that the transistor output remains closed;
- fail "No Effect": failure mode of a component that plays a part in implementing the safety function but that is neither a safe failure or a dangerous failure.

When calculating the SFF this failure mode is not taken into account;

- fail "Not part": failure mode of a component which is not part of the safety function but part of the circuit diagram and is listed for completeness.

When calculating the SFF this failure mode is not taken into account. It is also not considered for the total failure rate (safety function) evaluation.

Both channels Ch.1 and Ch.2 (as Ch.1 fault indicator) are functional safety related.

Failure rate date: taken from Siemens Standard SN29500.

Failure rate table (Out 1):

Failure category	Failure rates (FIT) Out 1
λ_{dd} = Total Dangerous Detected failures	0.00
λ_{du} = Total Dangerous Undetected failures	11.28
λ_{sd} = Total Safe Detected failures	0.00
λ_{su} = Total Safe Undetected failures	169.79
$\lambda_{tot\ safe}$ = Total Failure Rate (Safety Function) = $\lambda_{dd} + \lambda_{du} + \lambda_{sd} + \lambda_{su}$	181.07
MTBF (safety function, for In1 + Out1) = $(1 / \lambda_{tot\ safe}) + MTTR$ (8 hours)	630 years
$\lambda_{no\ effect}$ = "No Effect" failures	409.53
$\lambda_{not\ part}$ = "Not Part" failures	93.20
$\lambda_{tot\ device}$ = Total Failure Rate (Device) = $\lambda_{tot\ safe} + \lambda_{no\ effect} + \lambda_{not\ part}$	683.80
MTBF (device) = $(1 / \lambda_{tot\ device}) + MTTR$ (8 hours)	166 years

Failure rates table (Out 1) according to IEC 61508:2010 Ed.2 :

Out 1	λ_{sd}	λ_{su}	λ_{dd}	λ_{du}	SFF
	0.00 FIT	169.79 FIT	0.00 FIT	11.28 FIT	93.77%

PFDavg vs T[Proof] table (Out 1) (assuming Proof Test coverage of 99%), with determination of SIL supposing module contributes $\leq 10\%$ of total SIF dangerous failures:

T[Proof] = 1 year	T[Proof] = 2 years	T[Proof] = 20 years
PFDavg = 4.95 E-05 Valid for SIL 3	PFDavg = 9.91 E-05 Valid for SIL 3	PFDavg = 9.91 E-04 Valid for SIL 2

PFDavg vs T[Proof] table (Out 1) (assuming Proof Test coverage of 99%), with determination of SIL supposing module contributes $> 10\%$ of total SIF dangerous failures:

T[Proof] = 10 years
PFDavg = 4.95 E-04 Valid for SIL 3

Systematic capability SIL 3 for Out 1.

Failure rate table (Out 2):

Failure category	Failure rates (FIT) Out 2
λ_{dd} = Total Dangerous Detected failures	0.00
λ_{du} = Total Dangerous Undetected failures	10.36
λ_{sd} = Total Safe Detected failures	0.00
λ_{su} = Total Safe Undetected failures	169.25
$\lambda_{tot\ safe}$ = Total Failure Rate (Safety Function) = $\lambda_{dd} + \lambda_{du} + \lambda_{sd} + \lambda_{su}$	179.61
MTBF (safety function, for In1 + Out2) = $(1 / \lambda_{tot\ safe}) + MTTR$ (8 hours)	635 years
$\lambda_{no\ effect}$ = "No Effect" failures	410.99
$\lambda_{not\ part}$ = "Not Part" failures	93.20
$\lambda_{tot\ device}$ = Total Failure Rate (Device) = $\lambda_{tot\ safe} + \lambda_{no\ effect} + \lambda_{not\ part}$	683.80
MTBF (device) = $(1 / \lambda_{tot\ device}) + MTTR$ (8 hours)	166 years

Failure rates table (Out 2) according to IEC 61508:2010 Ed.2 :

Out 2	λ_{sd}	λ_{su}	λ_{dd}	λ_{du}	SFF
	0.00 FIT	169.25 FIT	0.00 FIT	10.36 FIT	94.23%

PFDavg vs T[Proof] table (Out 2) (assuming Proof Test coverage of 99%), with determination of SIL supposing module contributes $\leq 10\%$ of total SIF dangerous failures:

T[Proof] = 1 year	T[Proof] = 2 years	T[Proof] = 20 years
PFDavg = 4.55 E-05 Valid for SIL 3	PFDavg = 9.09 E-05 Valid for SIL 3	PFDavg = 9.09 E-04 Valid for SIL 2

PFDavg vs T[Proof] table (Out 2) (assuming Proof Test coverage of 99%), with determination of SIL supposing module contributes $> 10\%$ of total SIF dangerous failures:

T[Proof] = 10 years
PFDavg = 4.55 E-04 Valid for SIL 3

Systematic capability SIL 3 for Out 2.

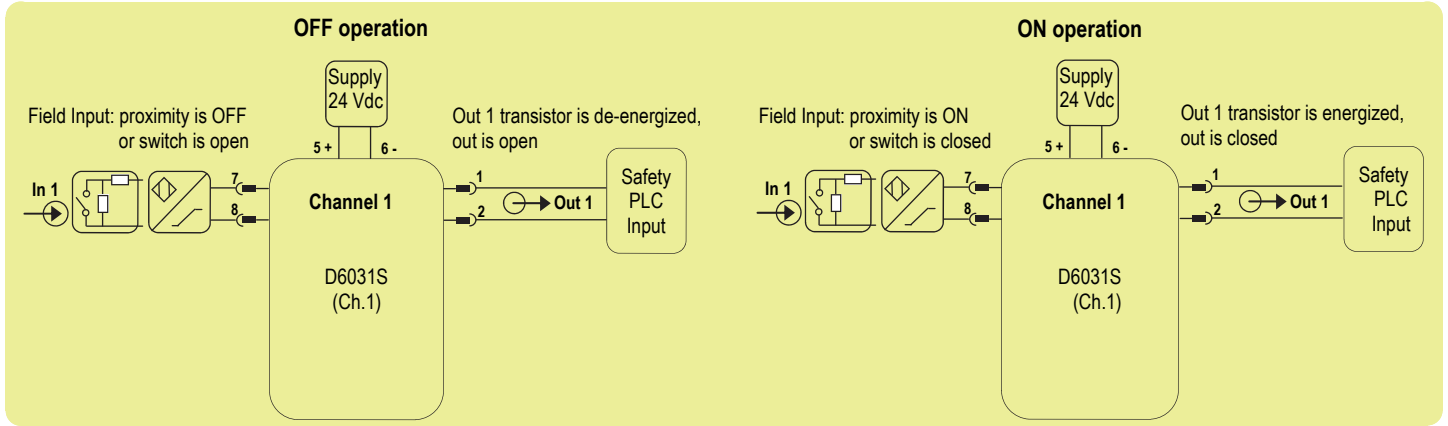

Description:

For this application, enable input line fault (open or short) detection and direct input to output transfer function, by set the internal dip-switches in the following mode (see page 10 for more information):

Dip-switch position	1	2	3	4	5	6	7	8
ON/OFF state	ON	OFF	Not used	Not used	ON	Not used	OFF	OFF

The module is powered by connecting 24 Vdc power supply to Pins 5 (+ positive) - 6 (- negative). The green LED is lit in presence of supply power.

Input signal from field is applied to Pins 7-8 (In 1 - Ch.1).

Transistor output Pins 1-2 (for Channel 1) is normally open (or transistor de-energized as safe state condition) for OFF operation, while it is closed (or transistor energized) for ON operation.

The following table describes for Channel 1 the state (open or closed) of its output when its input signal is in OFF or ON state, and it gives information about turn-on or turn-off of its channel status LED and channel fault LED:

Input 1 signal state Pins 7-8 (In 1 - Ch.1)	Transistor Out 1 state Pins 1-2 (Out 1 - Ch.1)	Channel 1 status yellow LED state	Channel 1 fault red LED state
Proximity sensor is OFF or switch is open	Open (De-energize transistor)	OFF	OFF
Proximity sensor is ON or switch is closed	Closed (Energized transistor)	ON	OFF
Independently from proximity sensor or switch state, the input line is break	Open (De-energized transistor as safe state condition)	OFF	ON
Independently from proximity sensor or switch state, the input line is in short circuit	Open (De-energized transistor as safe state condition)	OFF	ON

Safety Function and Failure behavior:

D6031S is considered to be operating in Low Demand mode, as a Type A module, having Hardware Fault Tolerance (HFT) = 0.

The failure behaviour is described from the following definitions :

- fail-Safe State: it is defined as the transistor output is open;
- fail Safe: failure mode that causes the module to go to the defined fail-safe state without a demand from the process;
- fail Dangerous: failure mode that does not respond to a demand from the process (i.e. being unable to go to the defined fail-safe state), so that the transistor output remains closed;
- fail "No Effect": failure mode of a component that plays a part in implementing the safety function but that is neither a safe failure or a dangerous failure.
When calculating the SFF this failure mode is not taken into account;
- fail "Not part": failure mode of a component which is not part of the safety function but part of the circuit diagram and is listed for completeness.
When calculating the SFF this failure mode is not taken into account. It is also not considered for the total failure rate (safety function) evaluation.

Failure rate date: taken from Siemens Standard SN29500.

Failure rate table:

Failure category	Failure rates (FIT)
λ_{dd} = Total Dangerous Detected failures	0.00
λ_{du} = Total Dangerous Undetected failures	11.20
λ_{sd} = Total Safe Detected failures	0.00
λ_{su} = Total Safe Undetected failures	117.46
$\lambda_{tot\ safe}$ = Total Failure Rate (Safety Function) = $\lambda_{dd} + \lambda_{du} + \lambda_{sd} + \lambda_{su}$	128.66
MTBF (safety function, channel 1) = $(1 / \lambda_{tot\ safe}) + MTTR$ (8 hours)	887 years
$\lambda_{no\ effect}$ = "No Effect" failures	214.34
$\lambda_{not\ part}$ = "Not Part" failures	0.20
$\lambda_{tot\ device}$ = Total Failure Rate (Device) = $\lambda_{tot\ safe} + \lambda_{no\ effect} + \lambda_{not\ part}$	343.20
MTBF (device, channel 1) = $(1 / \lambda_{tot\ device}) + MTTR$ (8 hours)	332 years

Failure rates table according to IEC 61508:2010 Ed.2 :

λ_{sd}	λ_{su}	λ_{dd}	λ_{du}	SFF
0.00 FIT	117.46 FIT	0.00 FIT	11.20 FIT	91.29%

PFDavg vs T[Proof] table (assuming Proof Test coverage of 99%), with determination of SIL supposing module contributes ≤10% of total SIF dangerous failures:

T[Proof] = 1 year	T[Proof] = 2 years	T[Proof] = 20 years
PFDavg = 4.91 E-05 Valid for SIL 3	PFDavg = 9.82 E-05 Valid for SIL 3	PFDavg = 9.82 E-04 Valid for SIL 2

PFDavg vs T[Proof] table (assuming Proof Test coverage of 99%), with determination of SIL supposing module contributes >10% of total SIF dangerous failures:

T[Proof] = 10 years
PFDavg = 4.91 E-04 Valid for SIL 3

Systematic capability SIL 3.

Testing procedure at T-proof

The proof test shall be performed to reveal dangerous faults which are undetected by diagnostic. This means that it is necessary to specify how dangerous undetected fault, which have been noted during the FMEDA, can be revealed during proof test.

Note for switch input: to detect a broken wire, or a short circuit condition, in the input connections it is necessary to mount, close to the switches, the end of line resistors: R1=1 KΩ typical (470 Ω to 2 KΩ range) resistor in series and R2=10 kΩ typical (5 KΩ to 15 KΩ range) resistor in parallel to the contacts.

The Proof test consists of the following steps:

Steps	Action
1	Bypass the safety-related PLC or take other appropriate action to avoid a false trip.
2	Vary the state conditions of the input sensors/contacts coming from field and verify that transistor outputs change from de-energized to energized and vice versa, then check that the de-energized state condition corresponds to the required safety-related function.
3	If input line fault detection is enable for each channel by means of Dip-switches specific set up, disconnect the input wiring coming from the field sensor/contact and check that the correspondent transistor output is de-energized. Then, put in short condition the input connections and verify that the same output remains de-energized. In both case the proper alarm LEDs, on the front panel, will be came red.
4	Restore the loop to full operation.
5	Remove the bypass from the safety-related PLC or restore normal operation.

This test will reveal approximately 99 % of possible Dangerous Undetected failures in the repeater.

Configuration

DIP Switch factory settings (valid for D6031S and D6031D)

SW1	SW2	SW3	SW4	SW5	SW6	SW7	SW8
OFF	OFF	OFF	OFF	OFF	OFF	OFF	OFF

D6031D (used as double channel) Configuration Summary Table : **WARNING:** dip-switch 6-7-8 must be set to "OFF" position.

Channel	1	2	Channel	1	2
Line fault detection	SW1	SW5	IN/OUT Operation	SW2	SW4
Disabled (switch/proximity sensor)	OFF	OFF	NO-NC or NC-NO	ON	ON
Enabled, <u>for SIL application</u> (proximity sensor or switch with end of line resistors, detects field open circuit and short circuit, de-energizes transistor in fault condition)	ON	ON	NO-NO or NC-NC (<u>for SIL application</u>)	OFF	OFF

D6031D (used as duplicator or fault output) Configuration Summary Table

WARNING: Terminals 9-10 must be shorted to set module as Duplicator or Fault Out. Dip-switch 3 must be set to "OFF" position.

Line fault detection	SW1	SW5	IN/OUT Operation Output 1	SW2
Disabled (switch/proximity sensor)	OFF	OFF	NO-NC or NC-NO	ON
Enabled, <u>for SIL application</u> (proximity sensor or switch with end of line resistors, detects field open circuit and short circuit, de-energizes relay in fault condition)	Output 1, (<u>for SIL application</u>) De-energized in Fault condition	ON	NO-NO or NC-NC (<u>for SIL application</u>)	OFF
	Output 1, Not specified Fault condition	OFF		

Output 2 Operation	SW6	SW7	SW8	Mode	SW4
Duplicator	De-energized in fault condition (<u>for SIL application</u>) if line fault detection enabled (SW1 ON)	ON	OFF	ON	Parallel (<u>for SIL application</u>) Set equal to SW2
	Not specified Fault condition	OFF			Reverse Set opposite to SW2
Fault Output	OFF (<u>for SIL application</u>)	ON	OFF	NO	ON
				NC (<u>for SIL application</u>)	OFF

D6031S Configuration Summary Table : **WARNING:** Dip-switch 7-8 must be set to "OFF" position.

Line fault detection	SW1	SW5	IN/OUT Operation	SW2
Disabled (switch/proximity sensor)	OFF	OFF	NO-NC or NC-NO	ON
Enabled, <u>for SIL application</u> (proximity sensor or switch with end of line resistors, detects field open circuit and short circuit, de-energizes relay in fault condition)	ON	ON	NO-NO or NC-NC (<u>for SIL application</u>)	OFF

D6031D used as double channel

A configuration DIP switch is located on component side of pcb. This switch allows the configuration of input/output relationship, fault detection functions and operating mode.

WARNING: dip-switch 6-7-8 must be set to "OFF" position.

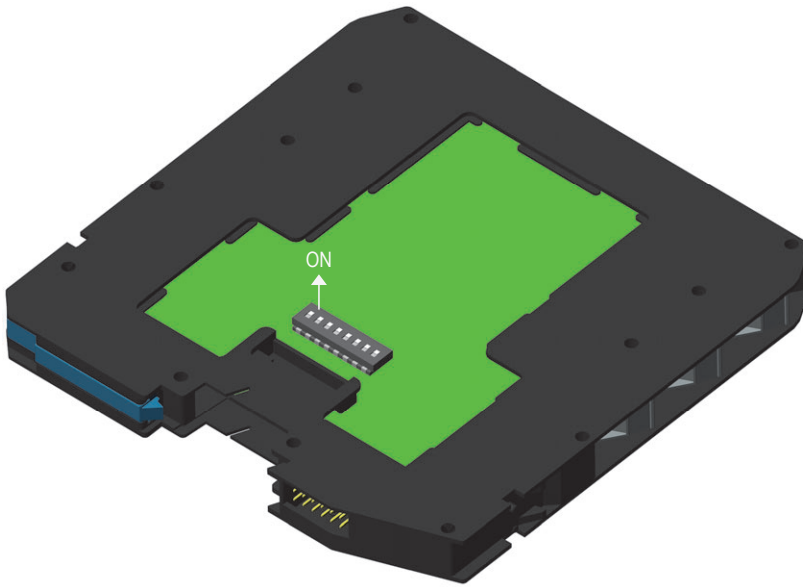

Dip switch factory settings. All Switches are OFF

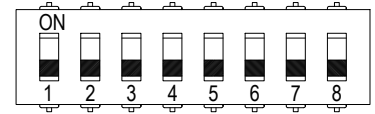

Dip switch configuration

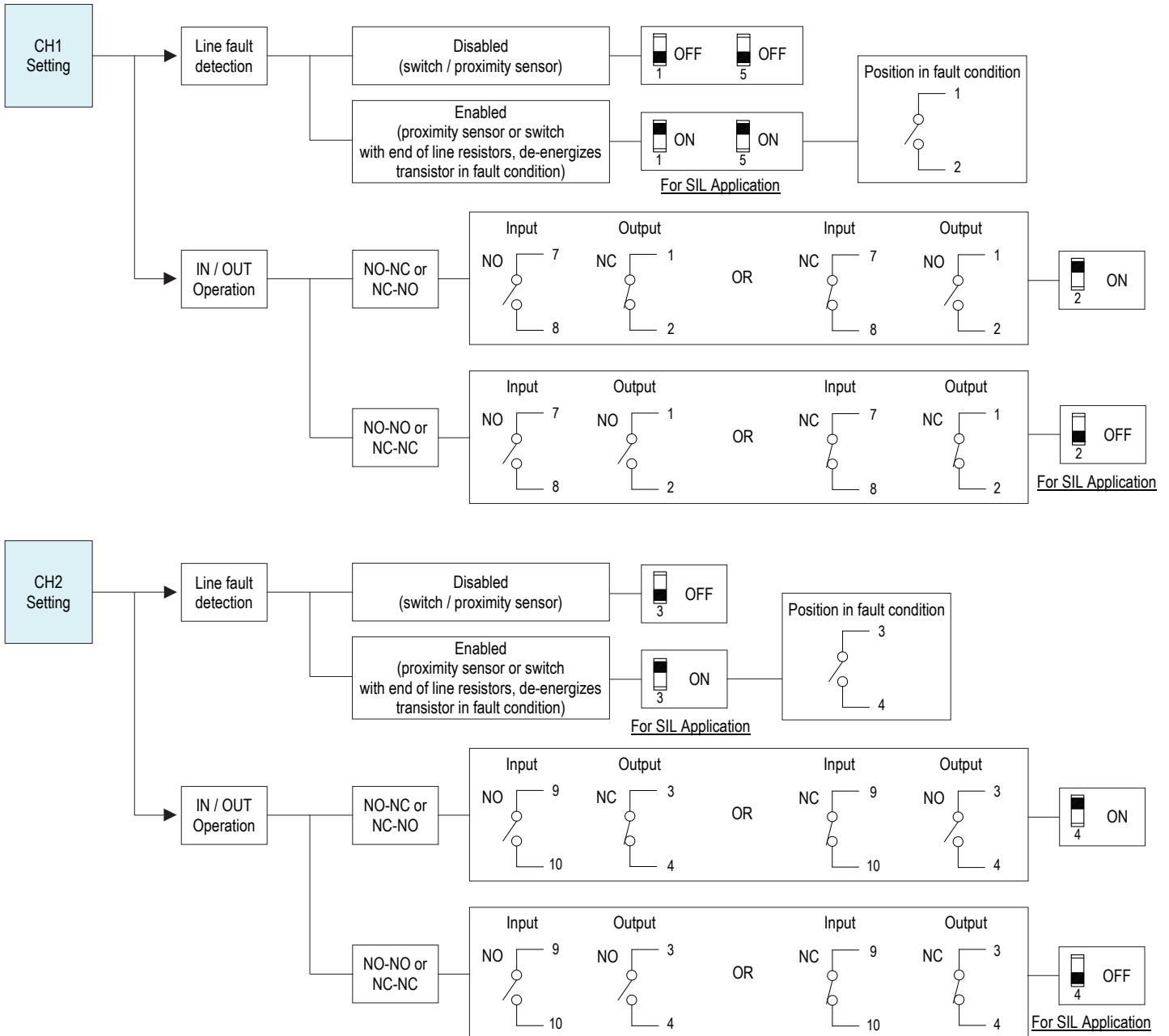
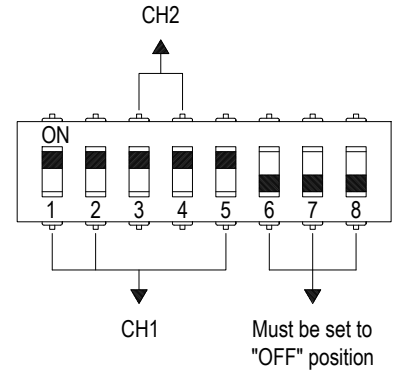

D6031D used as duplicator or fault output

A configuration DIP switch is located on component side of pcb. This switch allows the configuration of input/output relationship, fault detection functions and operating mode.

WARNING: Terminals 9-10 must be shorted to set module as Duplicator or Fault Out.

Dip-switch 3 **must be** set to "OFF" position.

Dip switch factory settings. All Switches are OFF

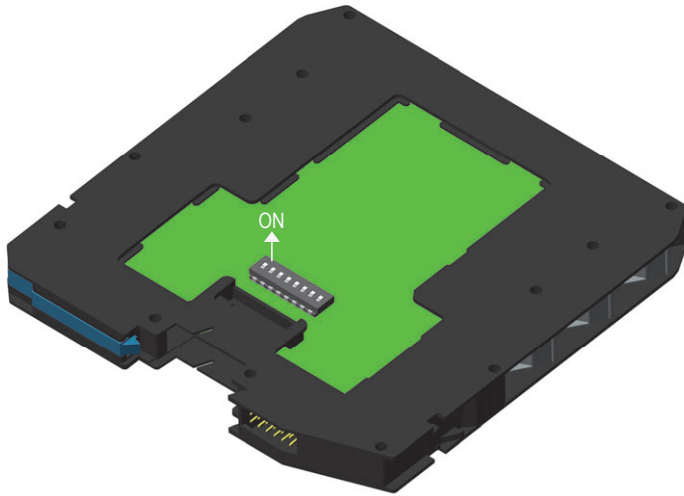
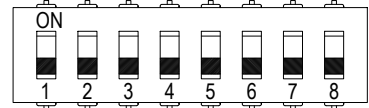

Dip switch configuration

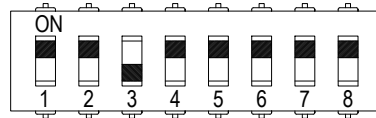

Must be set to "OFF" position

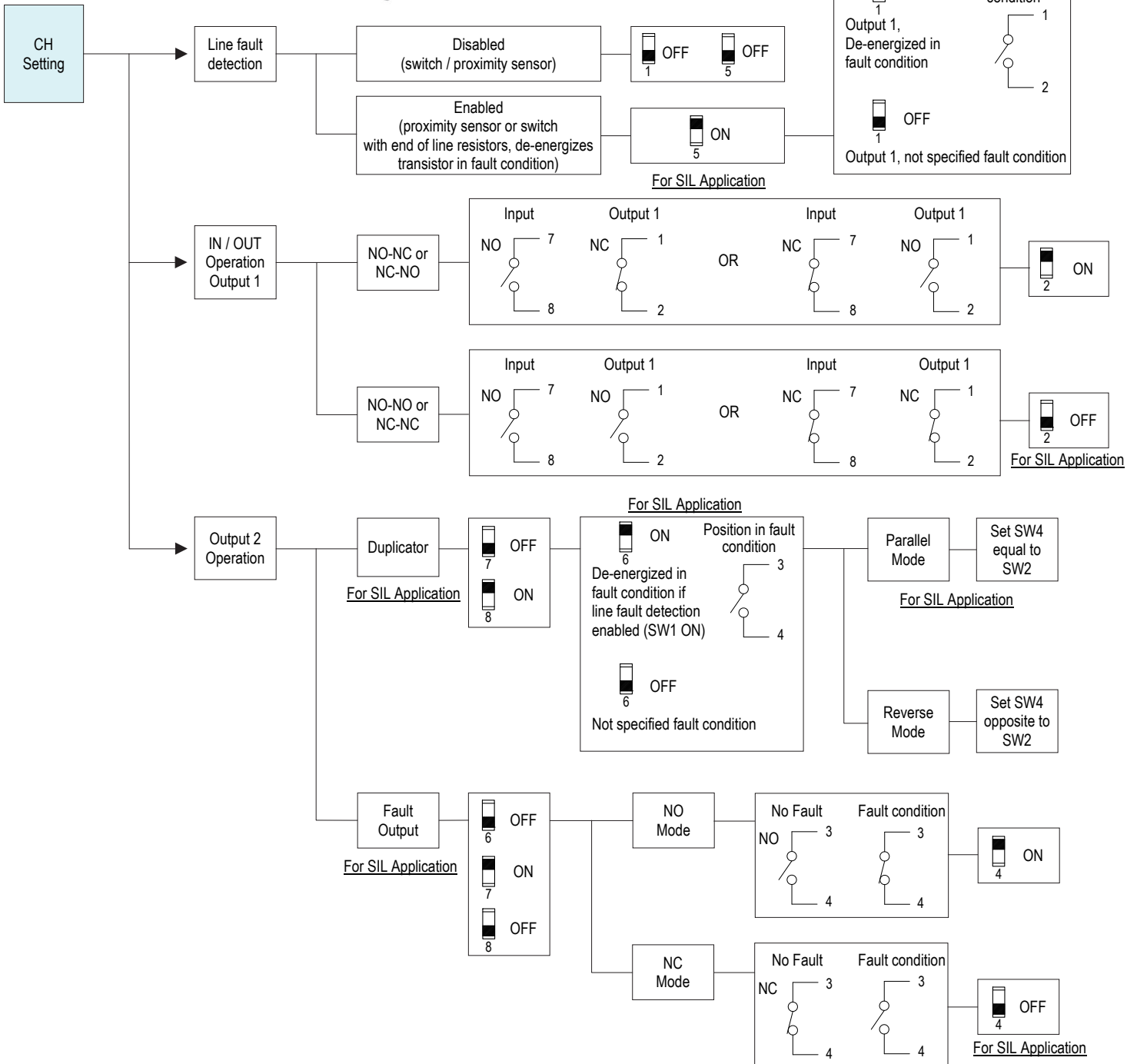

D6031S

A configuration DIP switch is located on component side of pcb. This switch allows the configuration of input/output relationship, fault detection functions and operating mode.

WARNING: Dip-switch 7-8 must be set to "OFF" position.

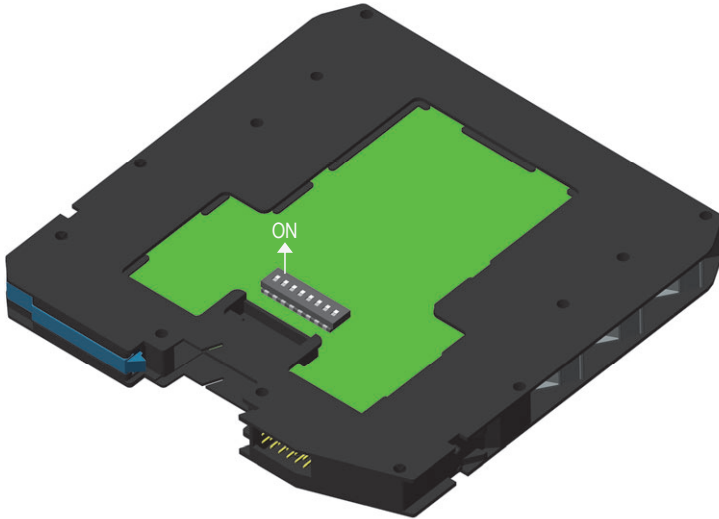

Dip switch factory settings. All Switches are OFF

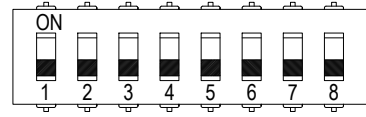

Dip switch configuration

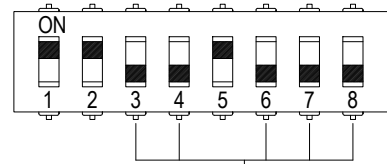

7-8 must be set to "OFF" position
3-4-6 Not used

