

Characteristics:
General description:

This Termination Board (TB) provides direct connection between the I/O Card of the system and D5000 Series modules. The Intrinsically Safe protection and signal isolation between Safe and Hazardous Area is provided by D5000 Series Associated Apparatus. The 24 Vdc Power Supply of the TB is connected to two plug-in terminal blocks, for a redundant power supply. The power supply for modules is given by TB power bus.

Termination Board general characteristics:

Termination Board Model	Number of positions	Features
TB-D5016-YOK-006	16	1) I/O Card redundancy; 2) Power Supply voltage redundancy; 3) HART multiplexing; 4) Abnormal supply voltage signaling; 5) Cumulative module fault signaling.

Supported Yokogawa Prosafe RS I/O Cards:

I/O Card Model	I/O Card Type	Number of channels per I/O Card	Number of I/O Cards per board	Number of channels per board	Supported GM Modules
SAI143*1	Analog In	16	1+(1)*2	16	D5011S D5014S*3 D5072S*3
			2+(2)*2	32	D5011D D5014D*3 D5072D*3

*1 card must be configured as current sink.

*2 with possibility of I/O Card redundancy.

*3 module must be configured as current source.

Features:

- 2 x AI card type SAI143 (16 channels) Analog Input board interface.
- 16 positions Terminal Board for up to 32 channels.
- Lower cables installation and maintenance costs.
- Power supplies fault monitoring.
- Spare fuse provided.
- Mounting hardware provided for:
 - Single Din Rail mounting kit;
 - Wall mounting, M4 self tapping screw;
 - Wall mounting, M4 thread screw.

Ordering Information:

Model: TB-D5016-YOK-006

Technical Data:
Supply:

24 Vdc nom (20 to 30 Vdc) reverse polarity protected, double terminal blocks for redundant power supply, with OR diodes to mix supply voltages.

Connection: by polarized plug-in disconnect screw terminal blocks to accommodate terminations up to 2.5 mm².

Protection fuse: 4 A slow blow (spare fuse provided on Termination Board).

Fault detection: (for more information see Fault Logic section)

Abnormal supply voltages or module cumulative fault: PWR 1 or PWR 2 is in under (< 18 Vdc) or over (> 30 Vdc) voltage condition OR module cumulative fault indication.

Relay fault signaling: a voltage free NE SPST-1 Form A relay contact (de-energized in fault condition), with the following characteristics:

Contact material: AgCdO.

Contact rating: 2 A 36 Vac 72 VA, 2 A 48 Vdc 80 W (resistive load).

Mechanical / Electrical life: 30 * 10⁶ / 1 * 10⁵ operation, typical.

Connection: by polarized plug-in disconnect screw terminal blocks to accommodate terminations up to 2.5 mm².

LED fault signaling: 1 green LED (PWR 1 OK); 1 green LED (PWR 2 OK); 1 red LED (UV or OV of PWR 1); 1 red LED (UV or OV of PWR 2); a cumulative fault red LED.

Prosafe RS I/O card interface:

Connection: four 40 poles male connectors (require female mating connectors).

HART Multiplexing:

Connection: two 34 poles male connectors (require female mating connectors).

Field signal:

Connection: directly to module by polarized plug-in disconnect screw terminal blocks to accommodate terminations up to 2.5 mm².

Environmental conditions:

Operating: temperature limits – 40 to + 70 °C, relative humidity max 90 % non condensing, up to 35 °C.

Storage: temperature limits – 45 to + 80 °C.

Mounting:

Hardware included for mounting on wall and single DIN rail.

Weight: about 400 g (excluding modules and mounting options).

Location: Safe Area / Ordinary locations.

Dimensions: Width 267 mm, Depth 176 mm, Height 125 mm.

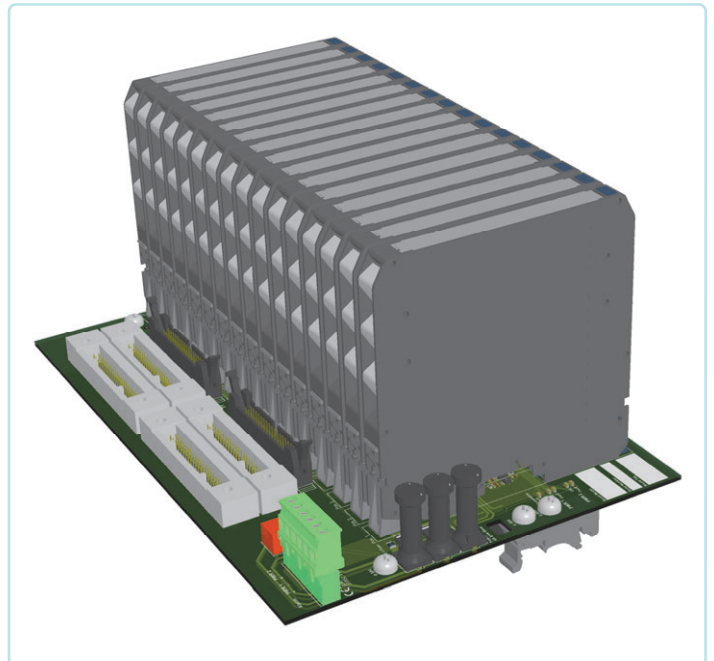
Image:

Loop Diagrams for Prosafe RS SAI143 (16AI) Interface Card:

HAZARDOUS AREA

SAFE AREA

TB position 1 to 16 for double channel AI module

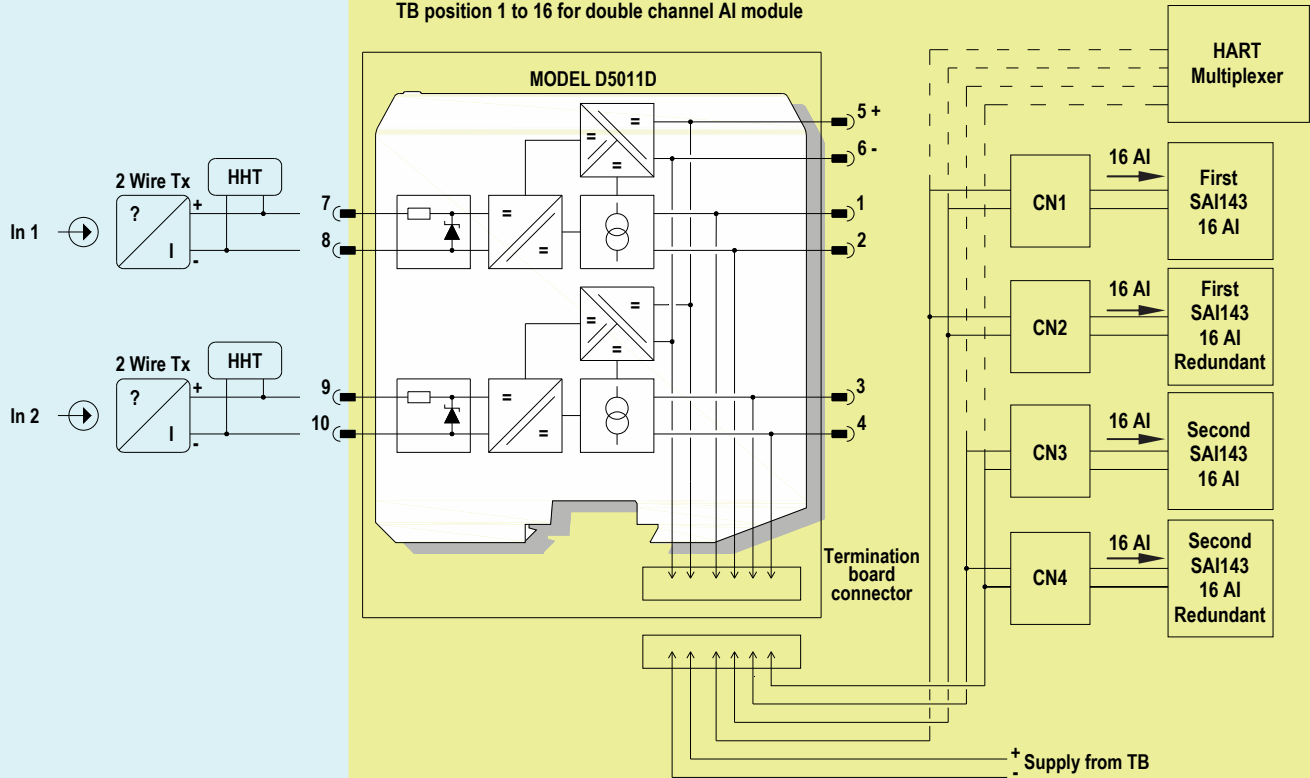

TB position 1 to 16 for single channel AI module

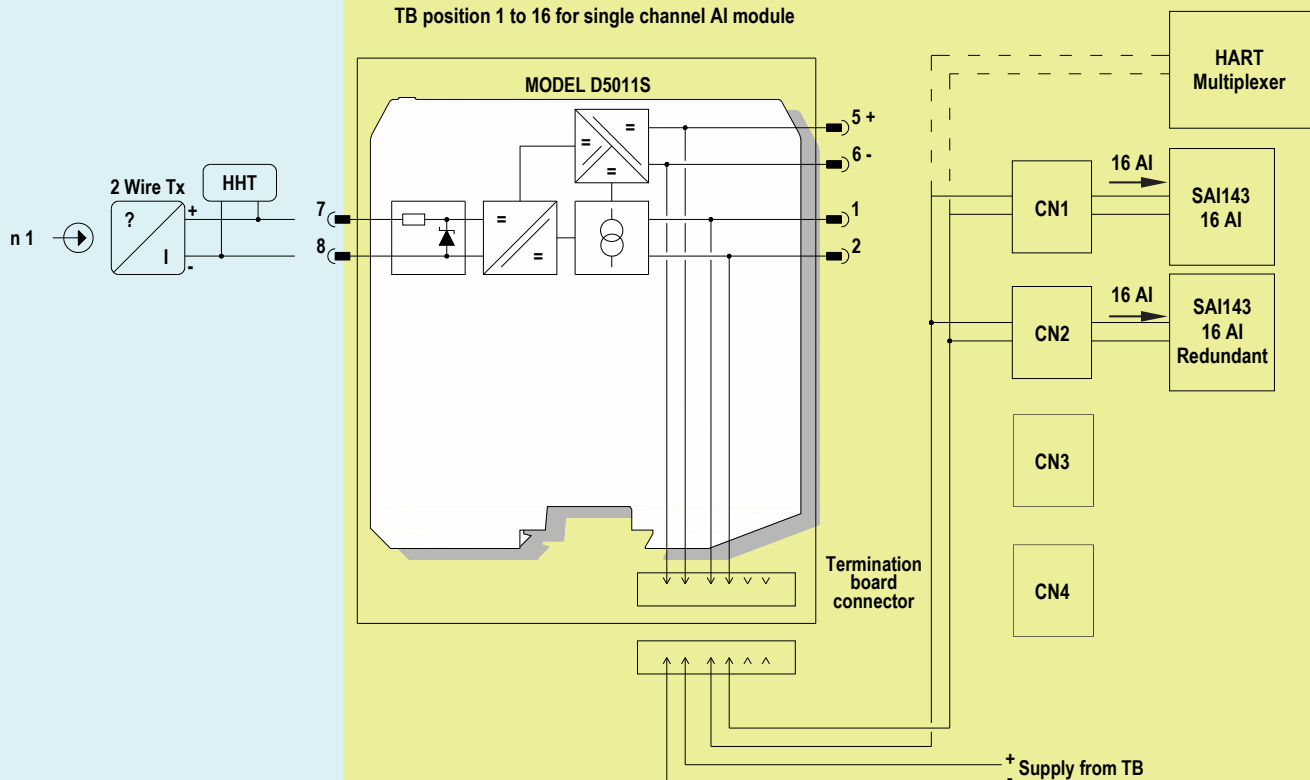

Loop Diagrams for Prosafe RS SAI143 (16AI) Interface Card:

HAZARDOUS AREA

SAFE AREA

TB position 1 to 16 for double channel AI module

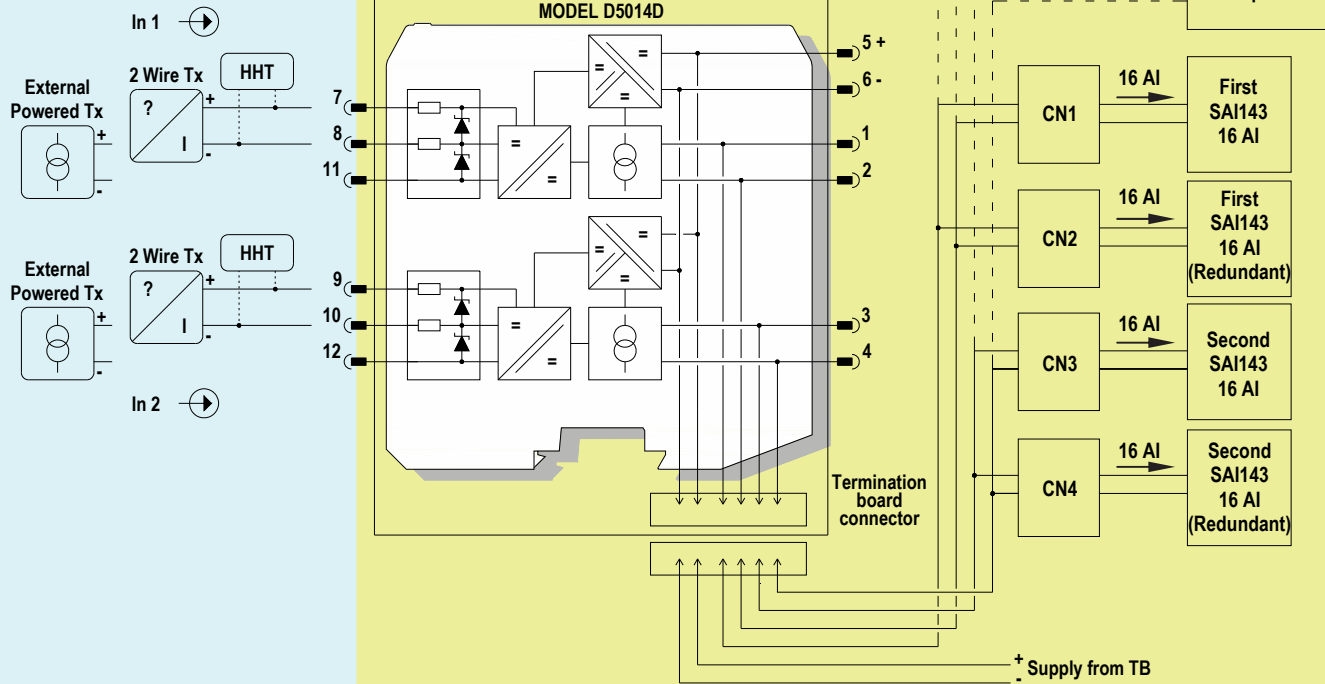

TB position 1 to 16 for single channel AI module

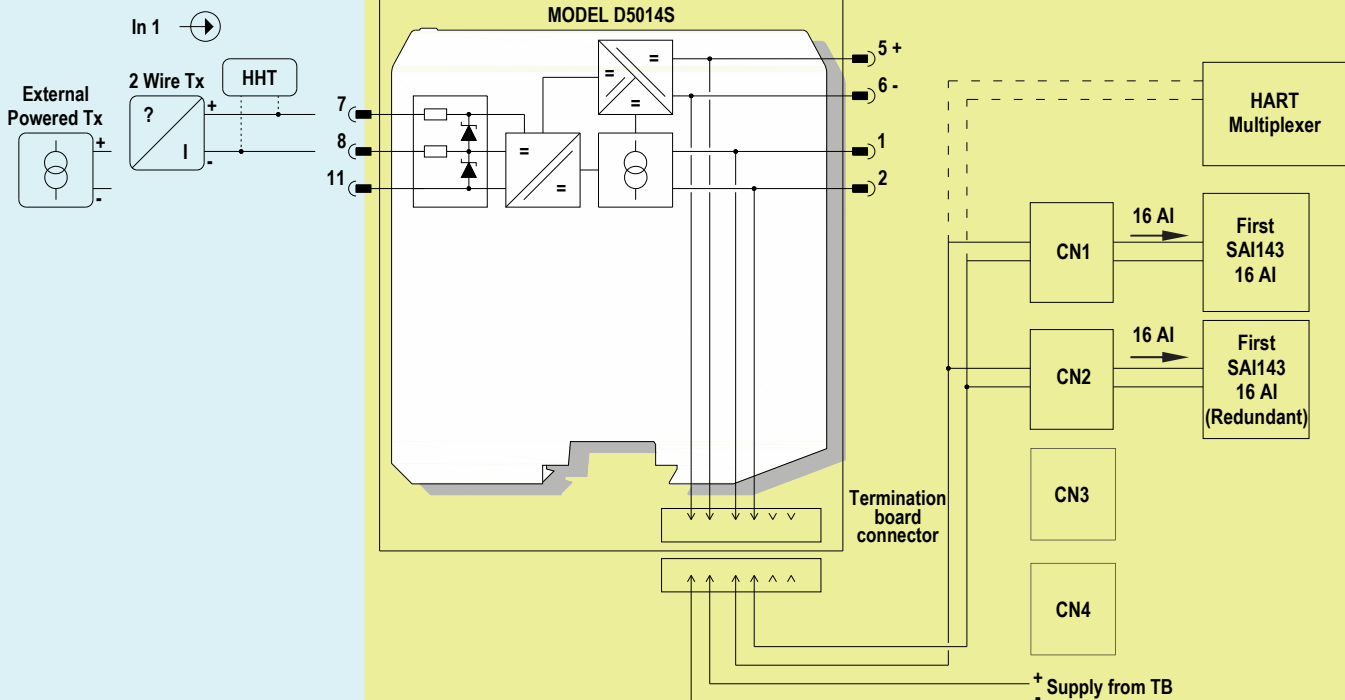

Loop Diagrams for Prosafe RS SAI143 (16AI) Interface Card:

HAZARDOUS AREA

SAFE AREA

TB position 1 to 16 for double channel Temperature module

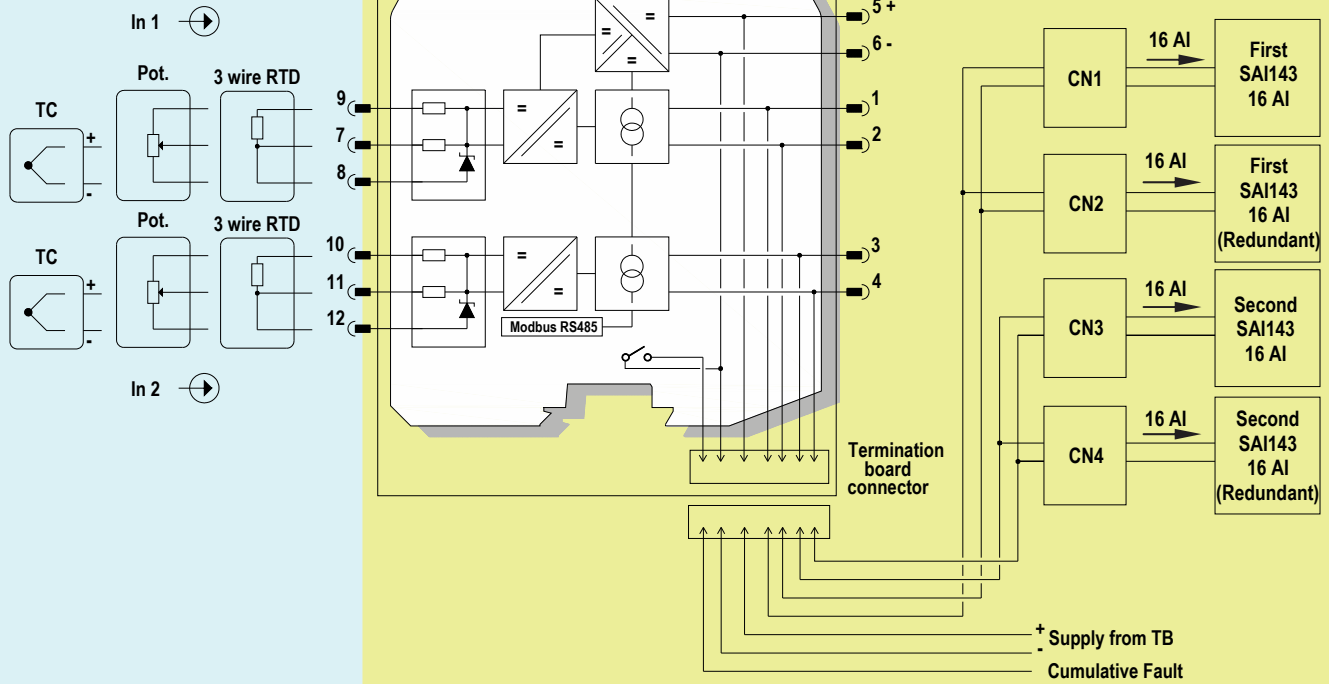

TB position 1 to 16 for single channel Temperature module

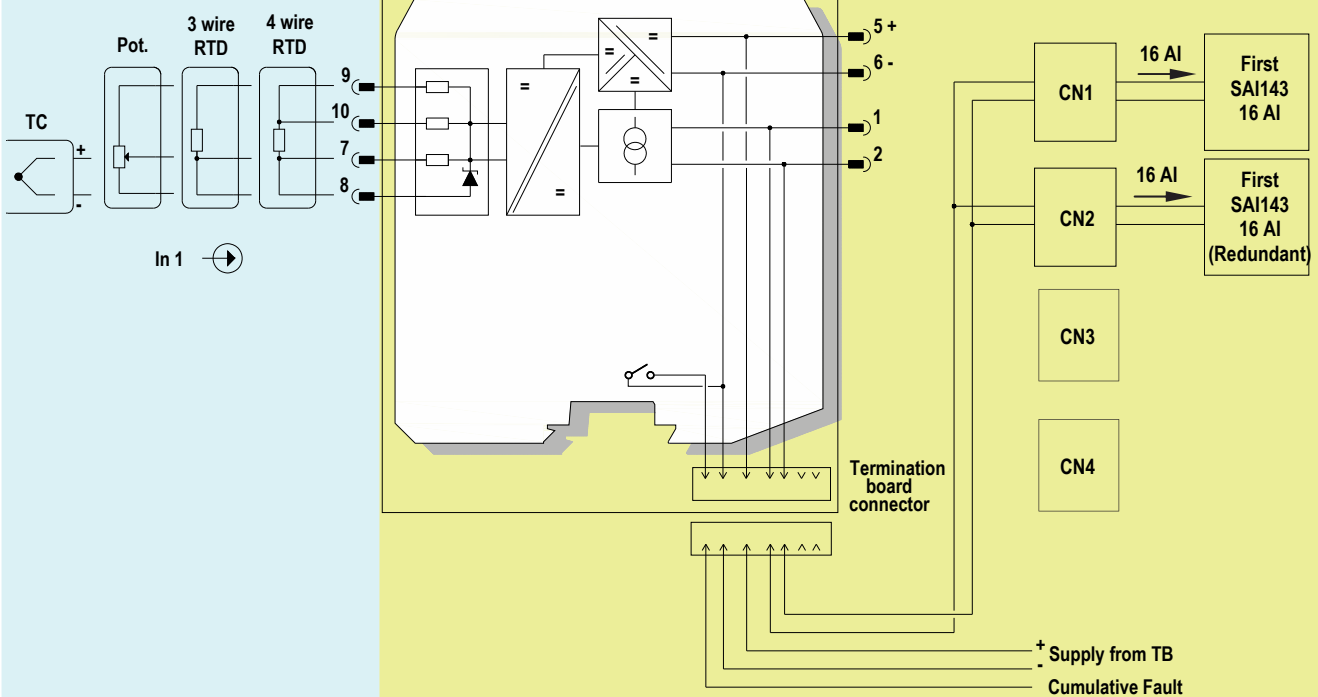

Termination Board Description:

HAZARDOUS AREA / LOCATION

SAFE AREA / ORDINARY LOCATION

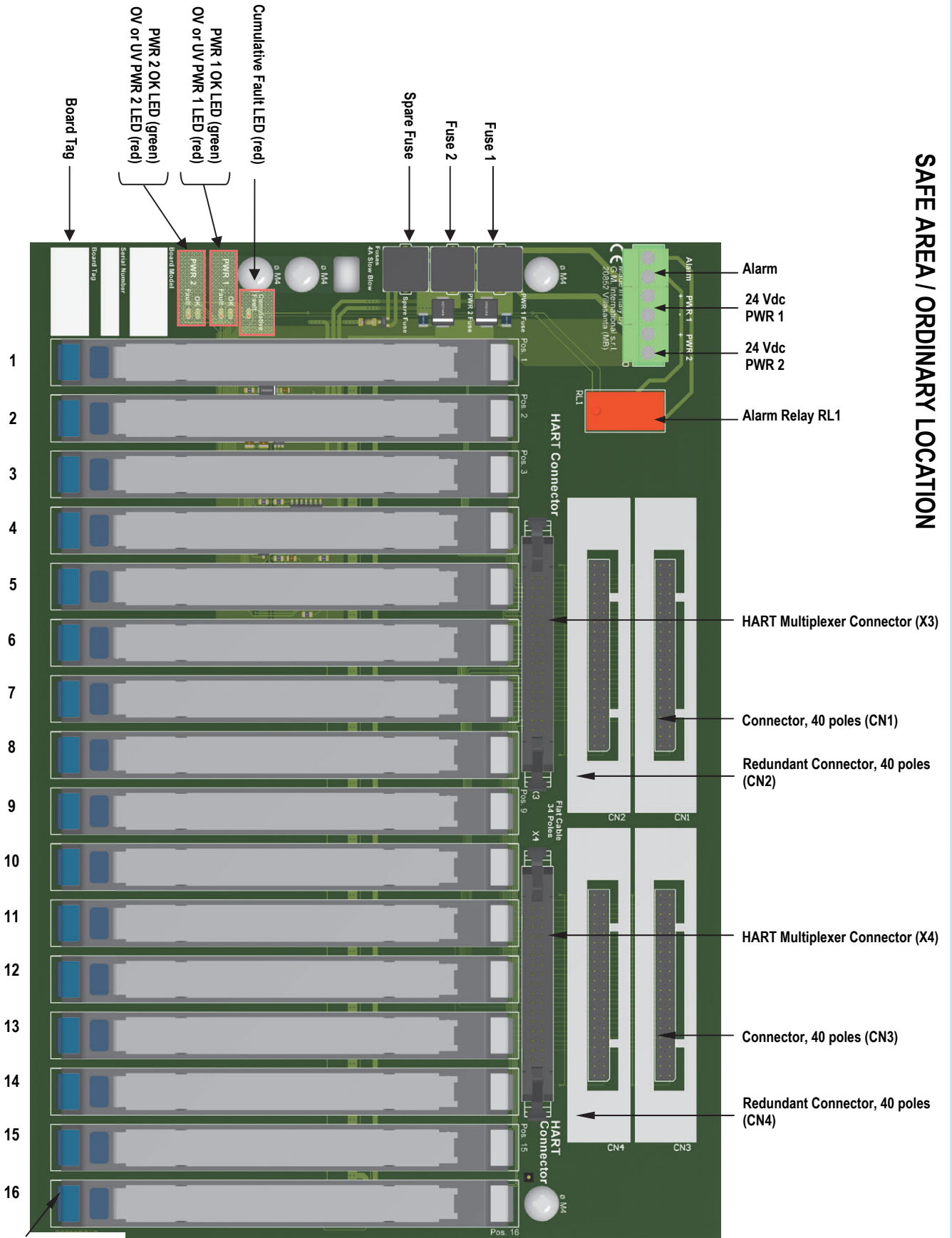

Termination Board Fault Logic:

LED Signaling:

Meaning of LEDs on termination boards:

TAG	LED COLOR	MEANING
PWR 1 OK	GREEN	The LED is on when PWR 1 is within the regular range (>18 V and <30 V).
PWR 1 Over or Under V	RED	The LED is on when PWR 1 is in over-voltage (>30V) or under-voltage (<18 V).
PWR 2 OK	GREEN	The LED is on when PWR 2 is within the regular range (>18 V and <30 V).
PWR 2 Over or Under V	RED	The LED is on when PWR 2 is in over-voltage (>30V) or under-voltage (<18 V).
Cumulative Fault	RED	The LED is on when at least one module / barrier reported a fault.

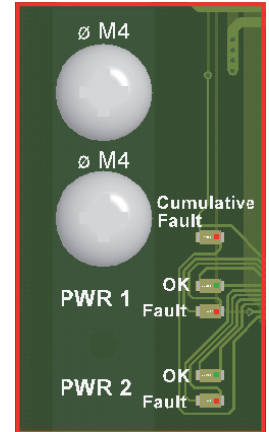

Relay Activation Conditions:

The two relays are activated according to the following rules:

TAG	ACTIVATION
ALARM	The relay is energized when the following two conditions hold: <ol style="list-style-type: none"> both supply voltages are within the regular range (>18 V and <30 V). No module / barrier fault is reported.

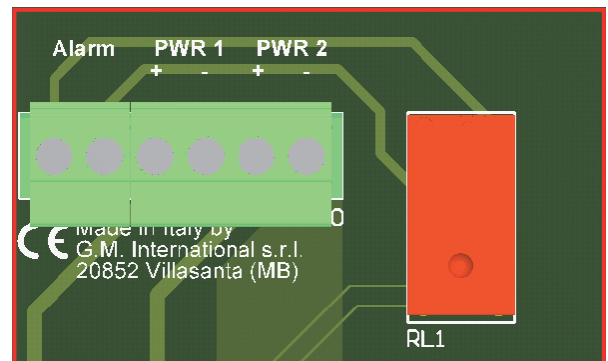

SAFE AREA / ORDINARY LOCATION

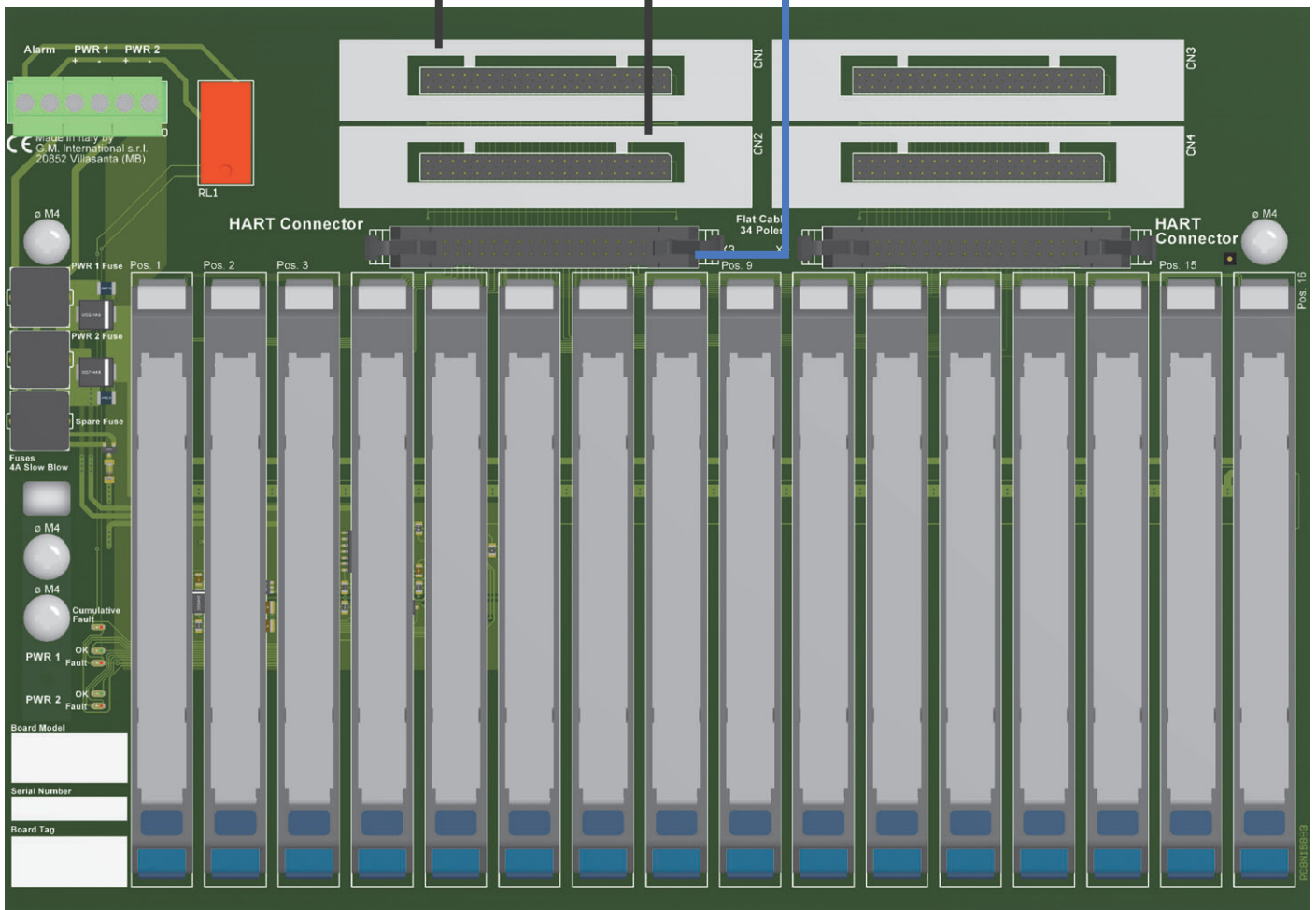
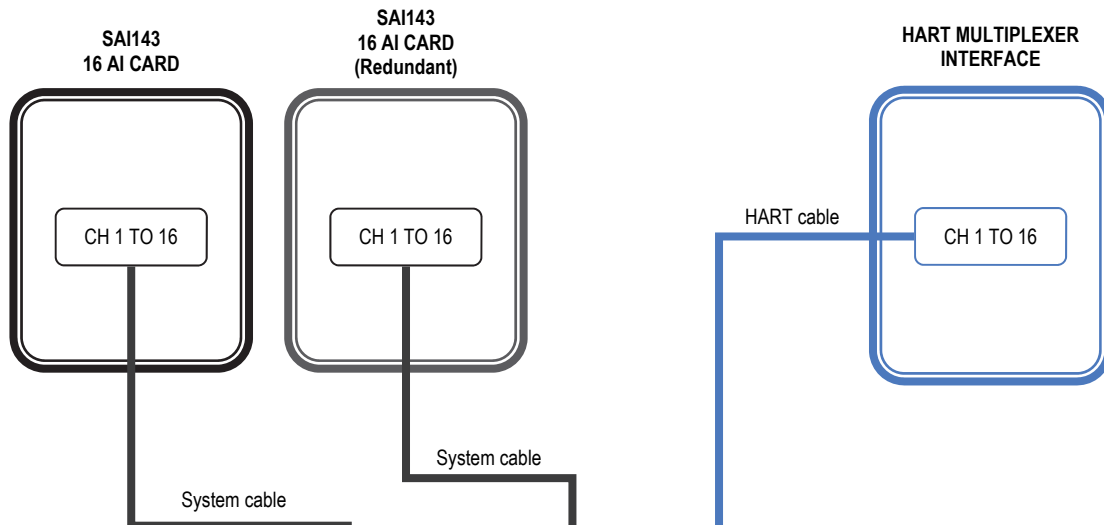

HAZARDOUS AREA / LOCATION

SAFE AREA / ORDINARY LOCATION

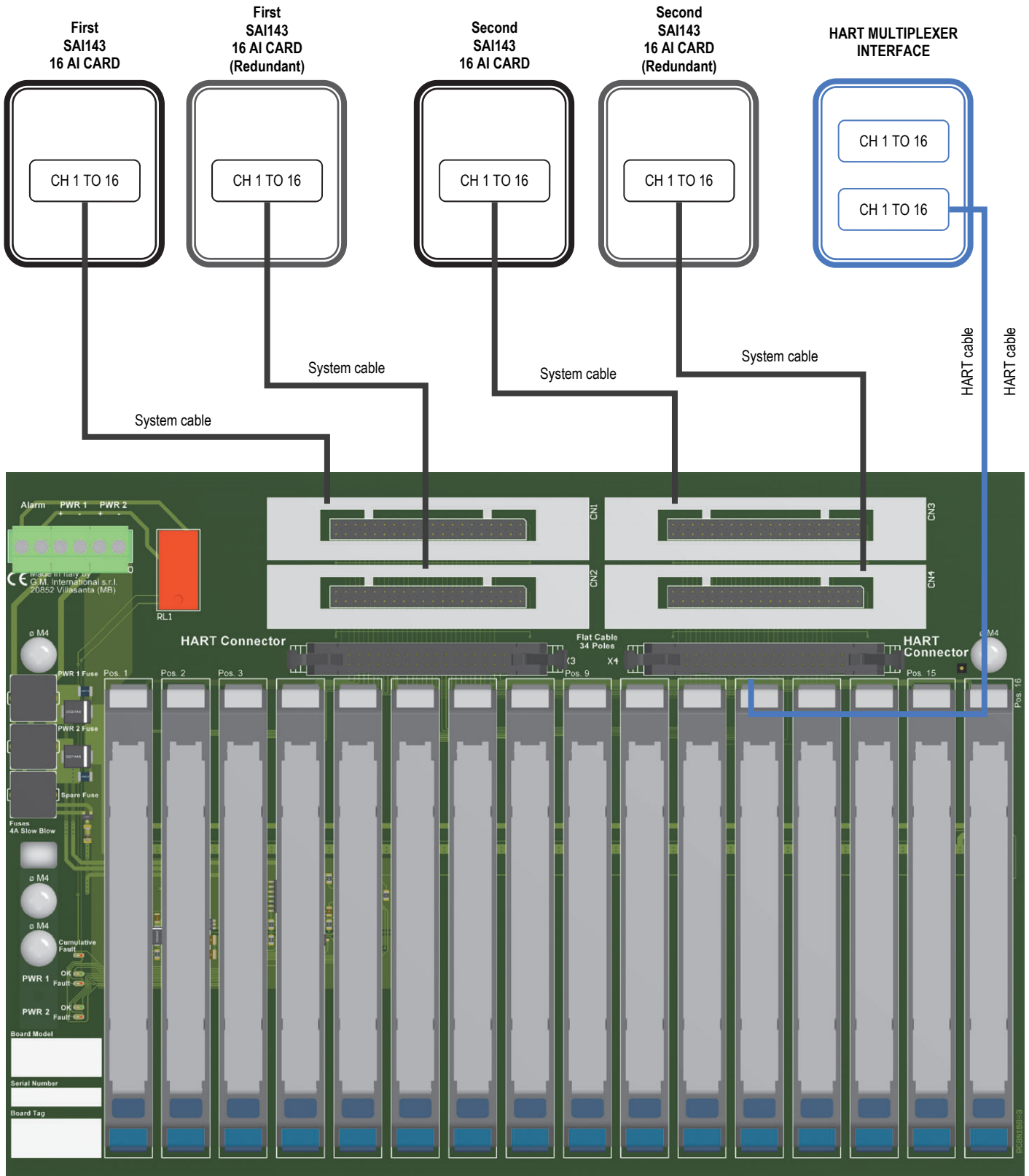

HAZARDOUS AREA / LOCATION

DIN Rail mounting overall dimensions:

Bottom view

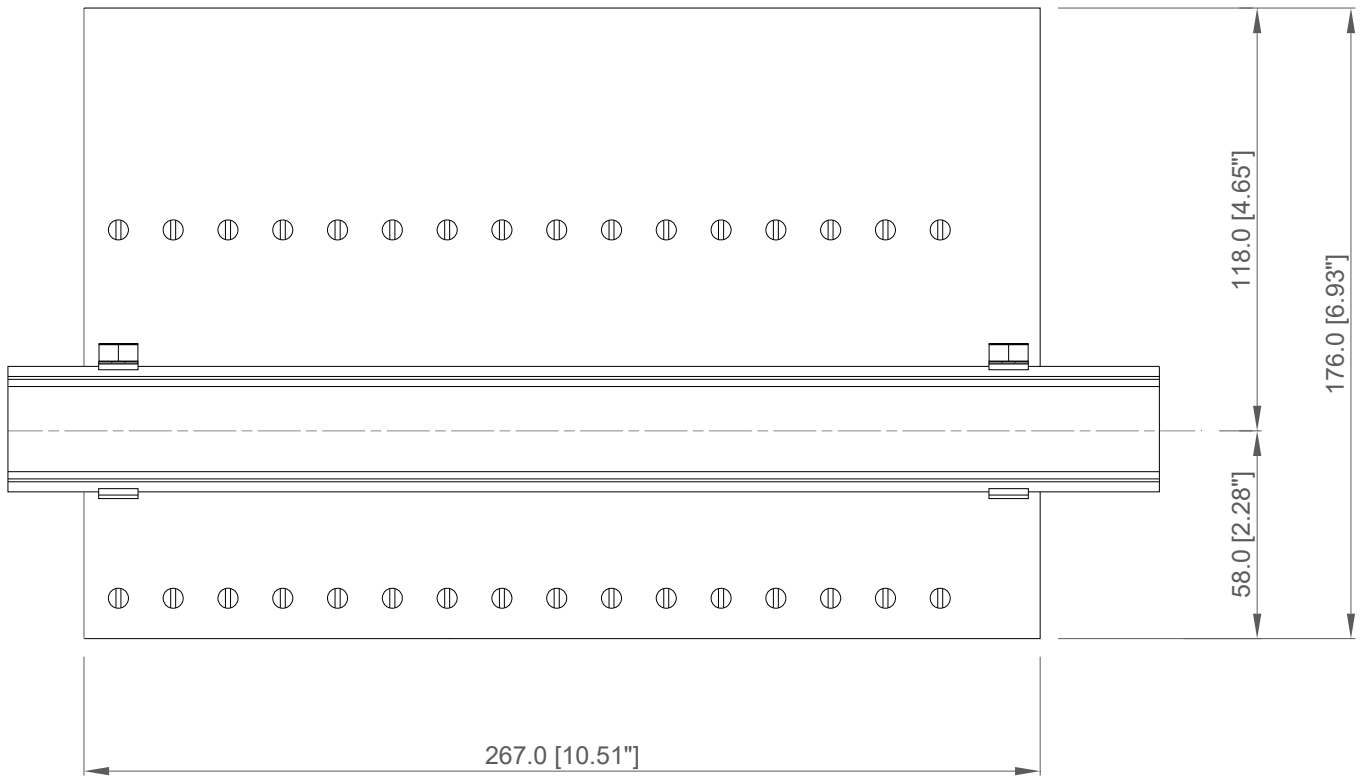

Side view

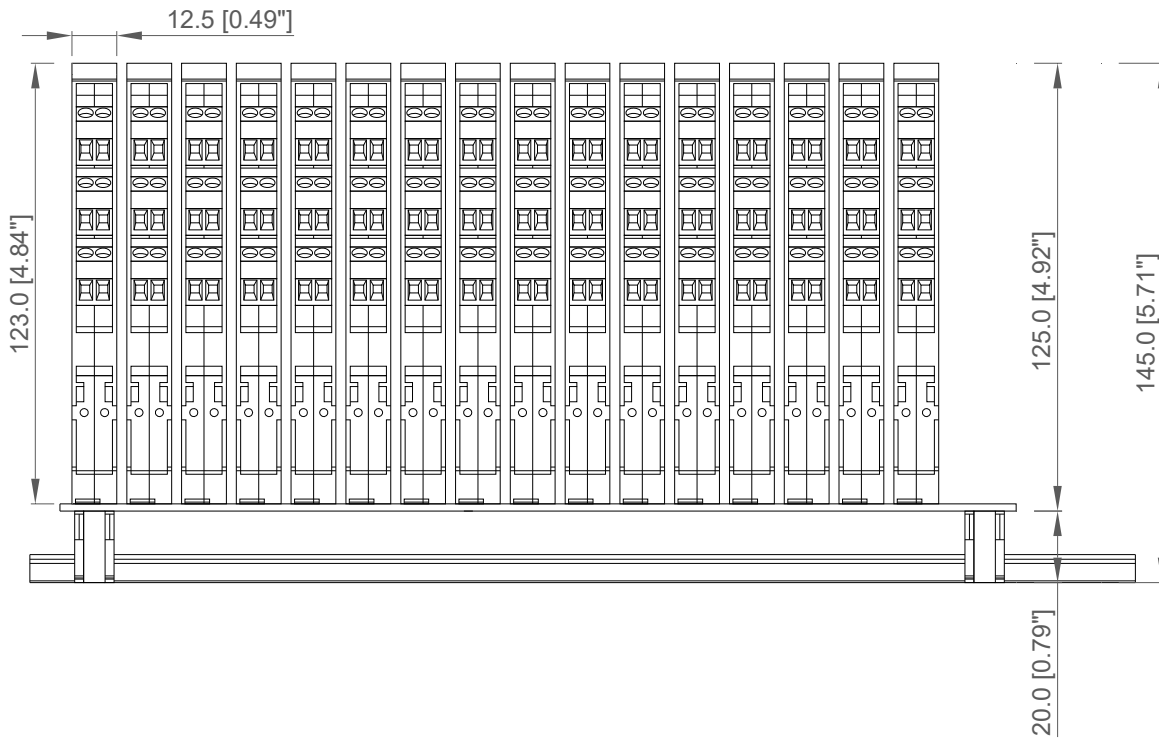

All dimensions are expressed in millimeters [inches]

Mounting features kit TB-OPT-001

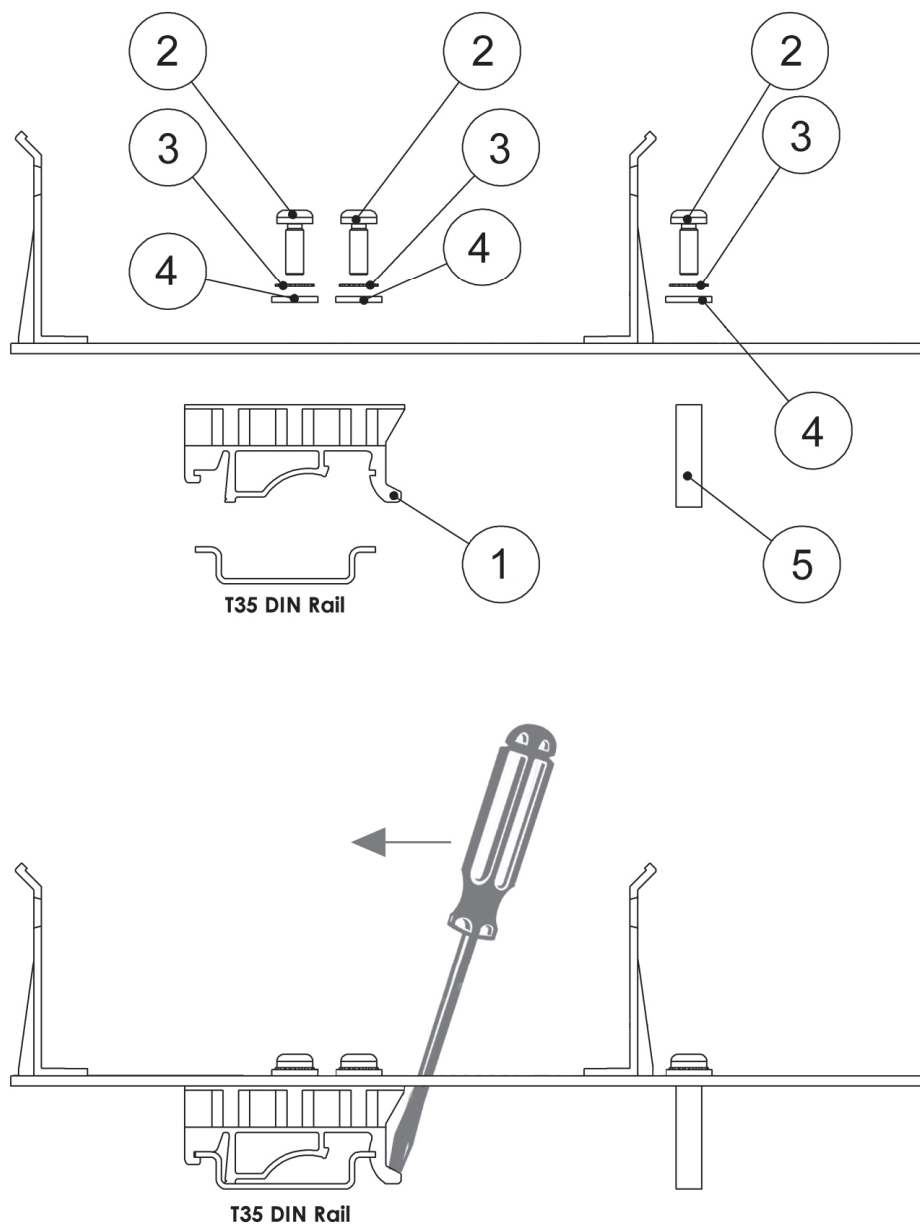

Ref. Nr	Q.ty	Description	Material
1	2	T35 Din Rail Adapter	PA
2	6	3.5 x 9.5 Self tapping screw	Stainless Steel
3	6	M3 External Tooth lock Washer	Stainless Steel
4	6	M3 Washer	Stainless Steel
5	2	6 c 20 Spacer	PA

Wall mounting overall dimensions for M4 self tapping screw:

Bottom view

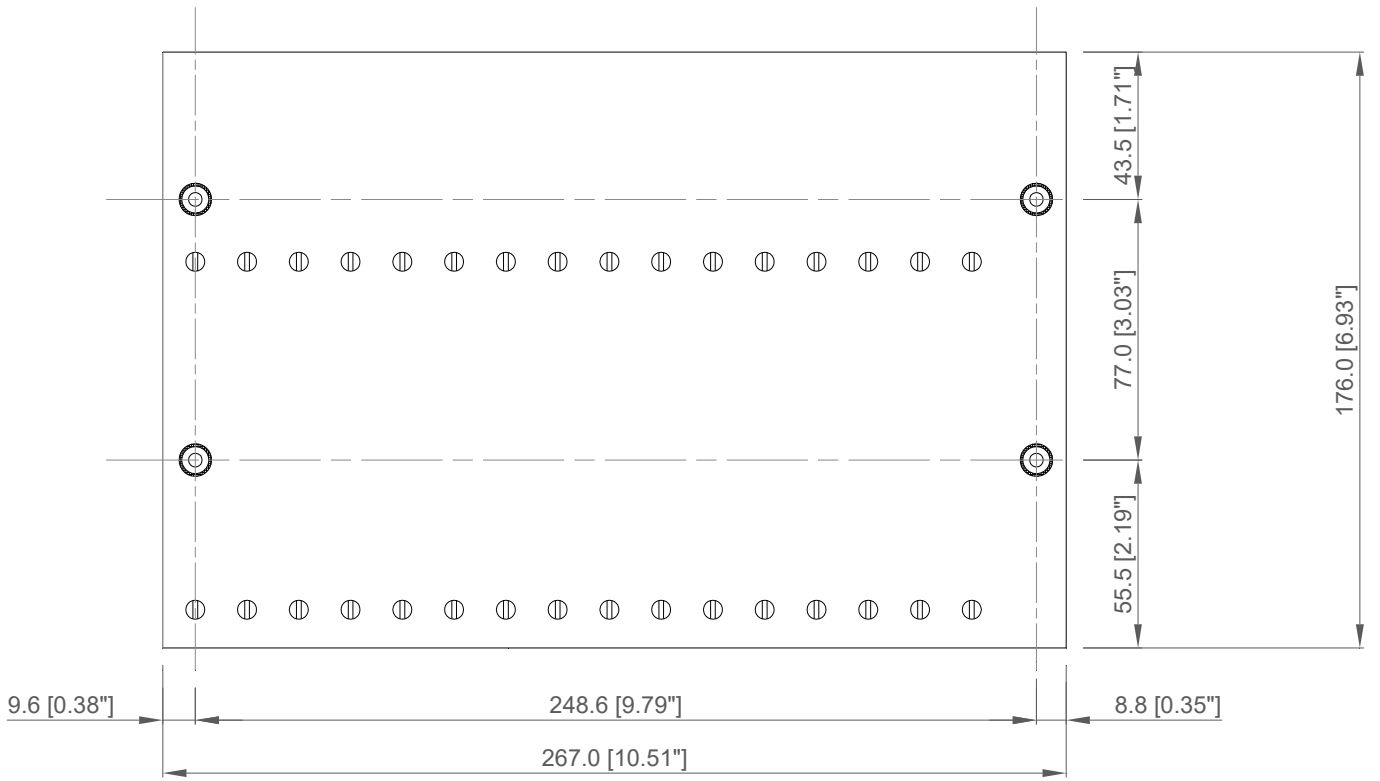

Side view

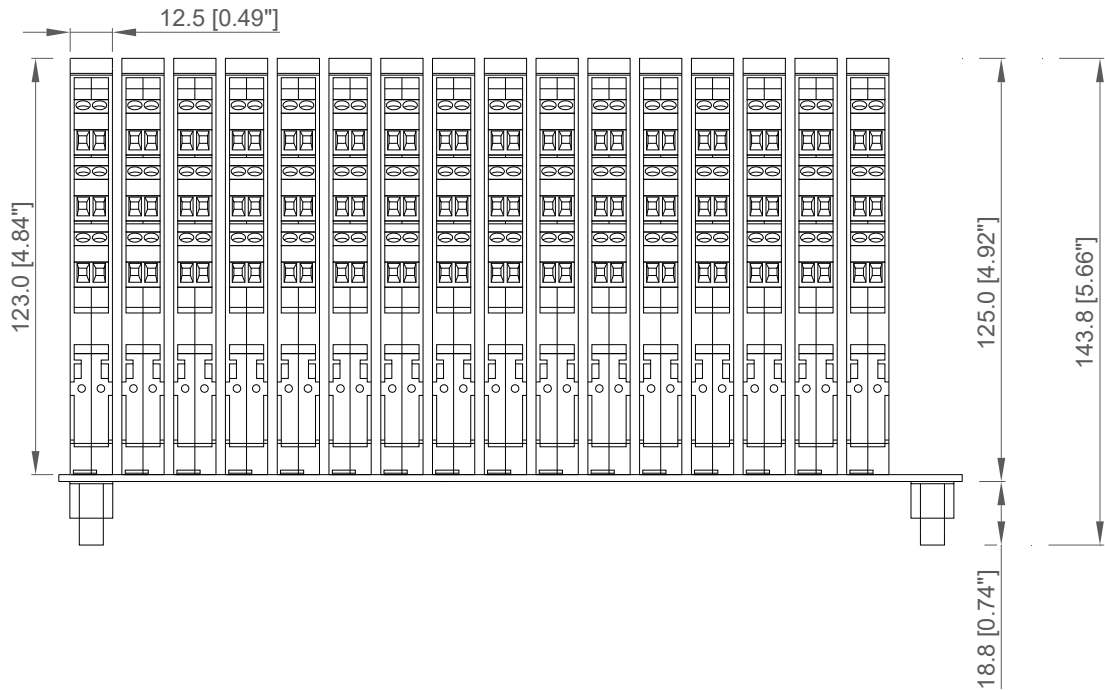

All dimensions are expressed in millimeters [inches]

Mounting features kit TB-OPT-001

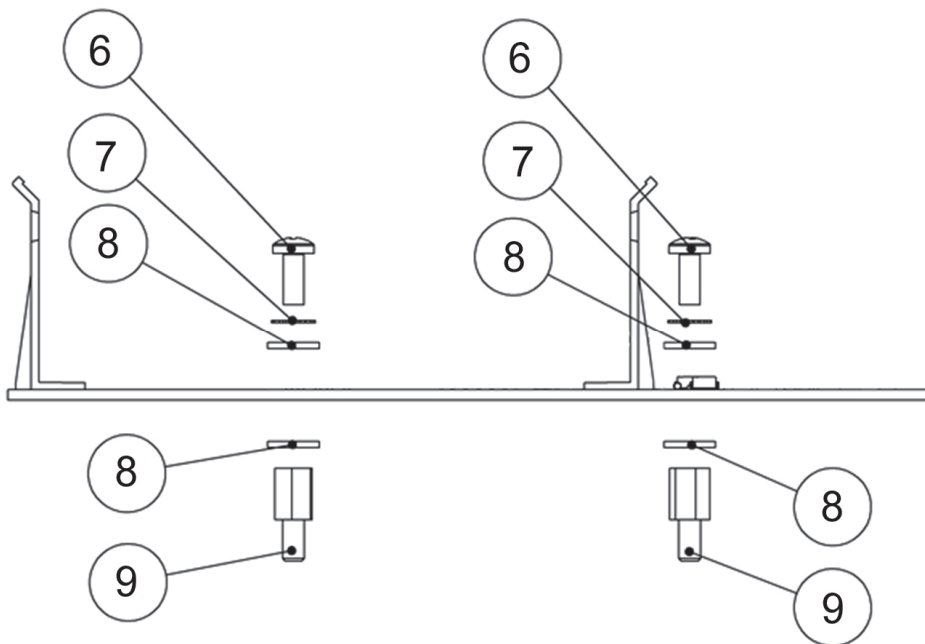
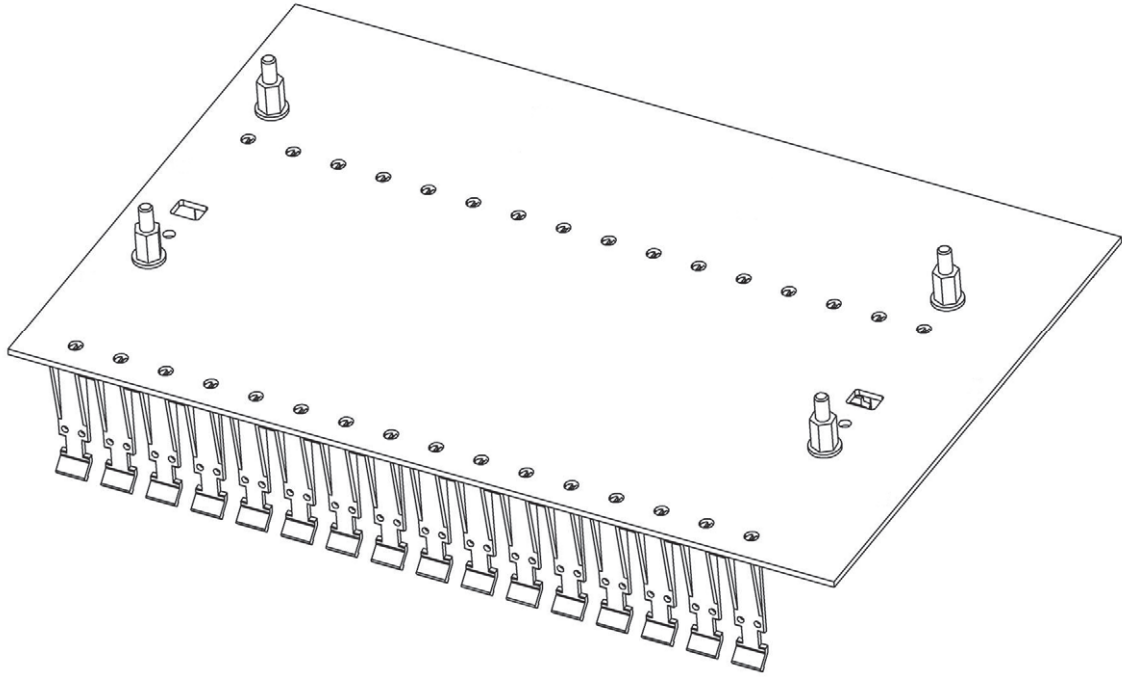

Ref. Nr	Q.ty	Description	Material
6	4	M4 x 8 Screw	Stainless Steel
7	4	M4 External Tooth lock Washer	Stainless Steel
8	8	M4 Washer	Stainless Steel
9	4	Self Tapping Spacer	NI - Plated Brass

Wall mounting overall dimensions for M4 thread screw:

Bottom view

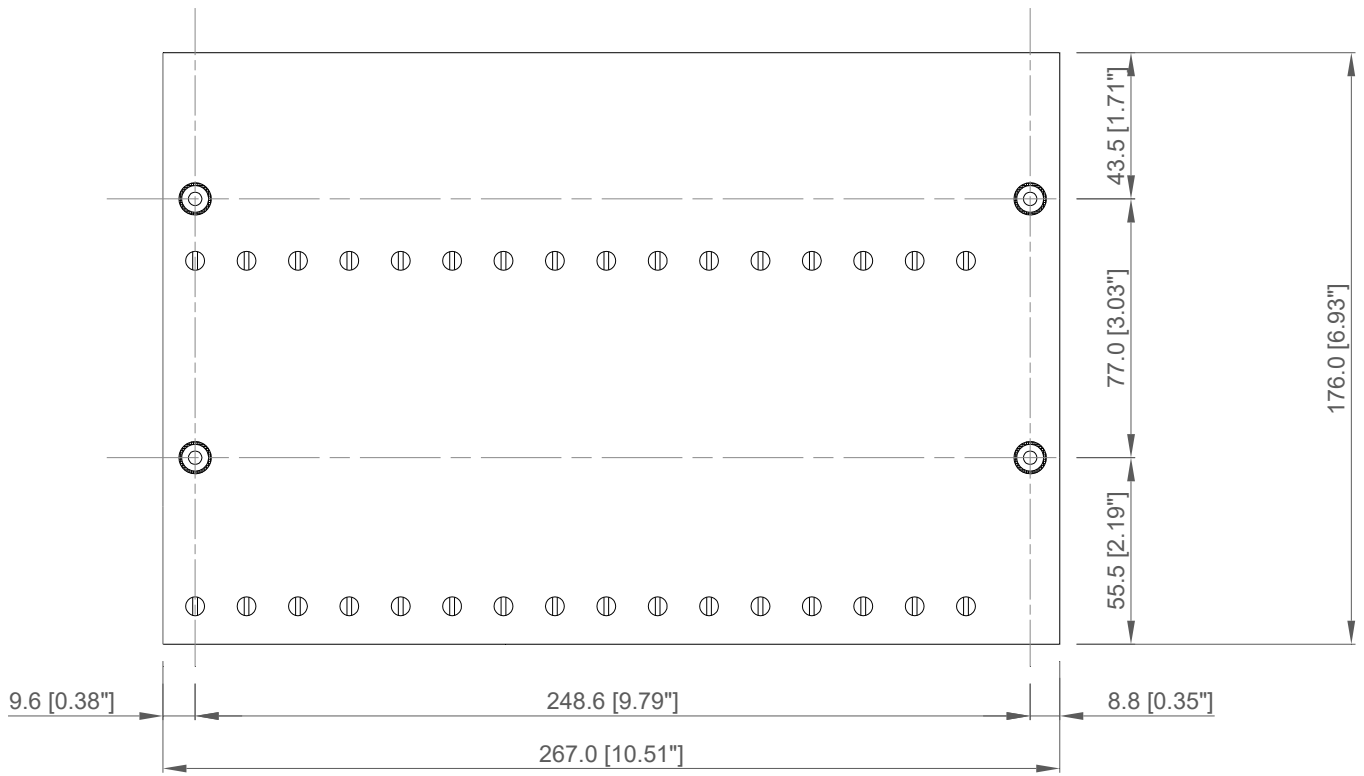

Side view

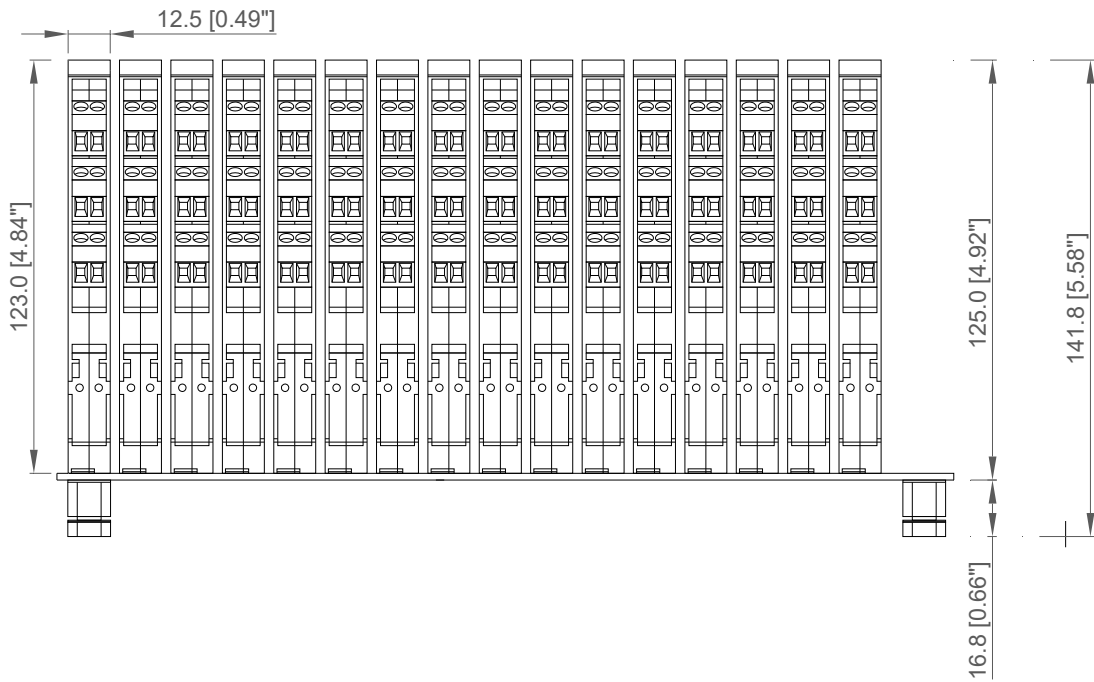

All dimensions are expressed in millimeters [inches]

Mounting features kit TB-OPT-001

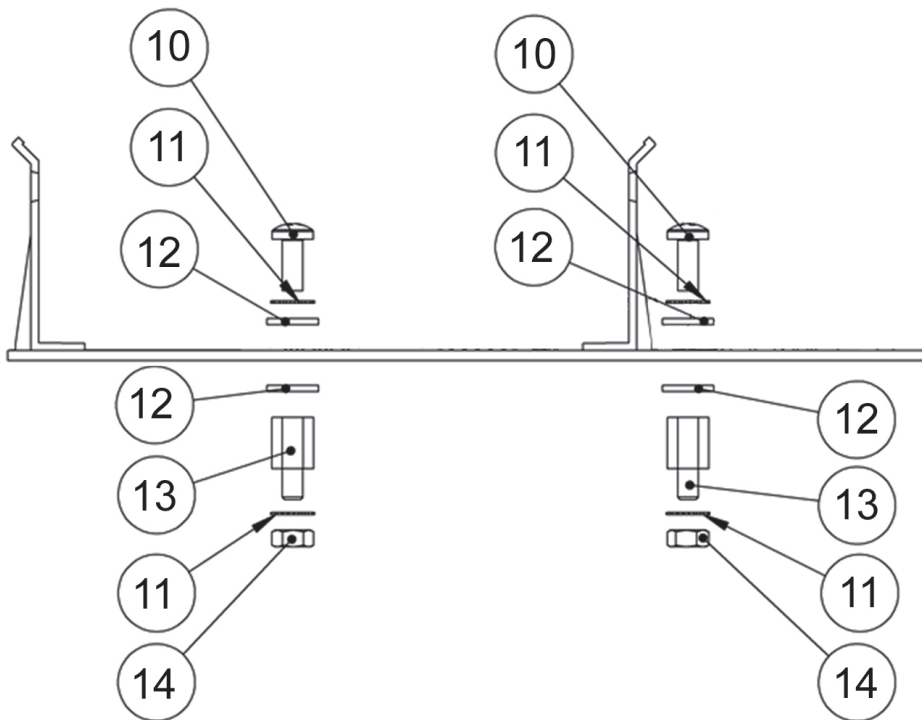
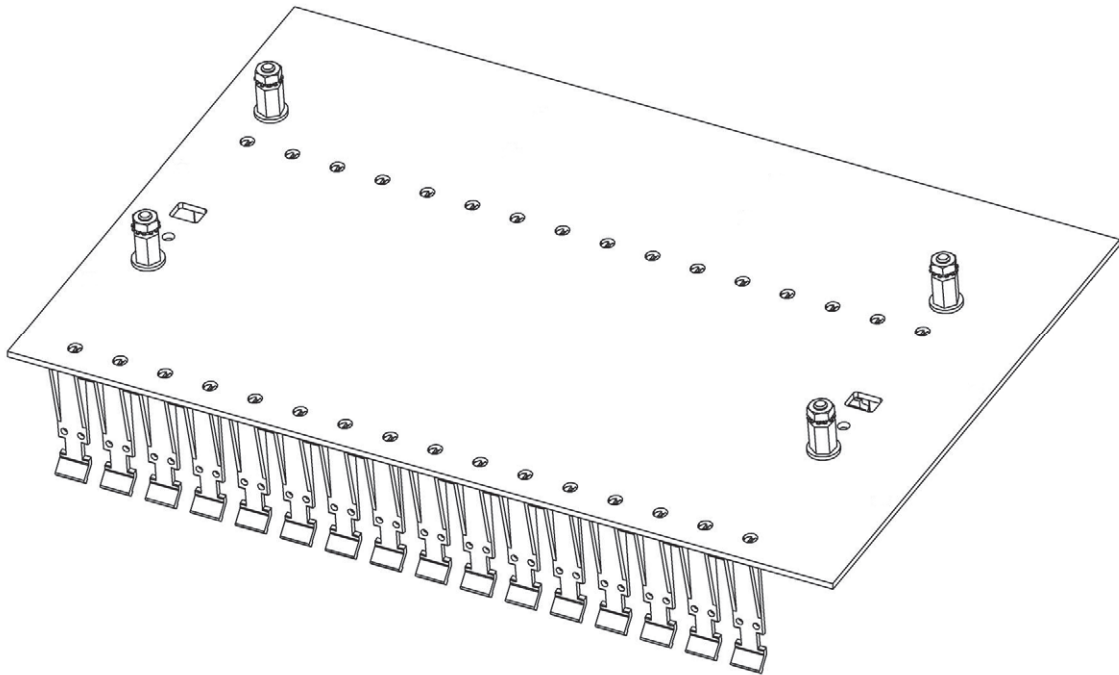

Ref. Nr	Q.ty	Description	Material
10	4	M4 x 8 Screw	Stainless Steel
11	8	M4 External Tooth lock Washer	Stainless Steel
12	8	M4 Washer	Stainless Steel
13	4	Threaded Spacer	NI - Plated Brass
14	4	M4 Nut	Stainless Steel

Connections table to Interface Card:

FIELD DEVICE	MODULE TYPE	MODULE FUNCTION	MODULE POSITION	MODULE CHANNEL NUMBER ("B" is only for Double channel)	INTERFACE CARD CHANNEL NUMBER	INTERFACE CARD CONN.(40 poles) PIN NUMBER	INTERFACE CARD REDUNDANT CONN.(40 poles) PIN NUMBER	HART MULTIPLEXING CONN.(34 poles) PIN NUMBER (D5011-14 only)	NOTE
	D5011S, D5014S (Single channel) - D5011D, D5014D (Double channel)	Analog IN (4-20 mA OUT)	1	1A	1 (1st SAI143)	(+ 37 (CN1) (-) 38 (CN1)	(+ 37 (CN2) (-) 38 (CN2)	(+ 1 (X3) (-) 2 (X3)	Interface Card Connectors CN1, CN2, CN3, CN4: 40 poles male. Poles No. 1 and No. 40 are connected together. The poles from No. 2 to No. 6 and No. 39 are not connected because not used. HART Multiplexing Connector X3, X4: The poles No. 33 and No. 34 are not connected because not used.
				1B	1 (2nd SAI143)	(+ 37 (CN3) (-) 38 (CN3)	(+ 37 (CN4) (-) 38 (CN4)	(+ 1 (X4) (-) 2 (X4)	
			2	2A	2 (1st SAI143)	(+ 35 (CN1) (-) 36 (CN1)	(+ 35 (CN2) (-) 36 (CN2)	(+ 3 (X3) (-) 4 (X3)	
				2B	2 (2nd SAI143)	(+ 35 (CN3) (-) 36 (CN3)	(+ 35 (CN4) (-) 36 (CN4)	(+ 3 (X4) (-) 4 (X4)	
			3	3A	3 (1st SAI143)	(+ 33 (CN1) (-) 34 (CN1)	(+ 33 (CN2) (-) 34 (CN2)	(+ 5 (X3) (-) 6 (X3)	
				3B	3 (2nd SAI143)	(+ 33 (CN3) (-) 34 (CN3)	(+ 33 (CN4) (-) 34 (CN4)	(+ 5 (X4) (-) 6 (X4)	
			4	4A	4 (1st SAI143)	(+ 31 (CN1) (-) 32 (CN1)	(+ 31 (CN2) (-) 32 (CN2)	(+ 7 (X3) (-) 8 (X3)	
				4B	4 (2nd SAI143)	(+ 31 (CN3) (-) 32 (CN3)	(+ 31 (CN4) (-) 32 (CN4)	(+ 7 (X4) (-) 8 (X4)	
			5	5A	5 (1st SAI143)	(+ 29 (CN1) (-) 30 (CN1)	(+ 29 (CN2) (-) 30 (CN2)	(+ 9 (X3) (-) 10 (X3)	
				5B	5 (2nd SAI143)	(+ 29 (CN3) (-) 30 (CN3)	(+ 29 (CN4) (-) 30 (CN4)	(+ 9 (X4) (-) 10 (X4)	
			6	6A	6 (1st SAI143)	(+ 27 (CN1) (-) 28 (CN1)	(+ 27 (CN2) (-) 28 (CN2)	(+ 11 (X3) (-) 12 (X3)	
				6B	6 (2nd SAI143)	(+ 27 (CN3) (-) 28 (CN3)	(+ 27 (CN4) (-) 28 (CN4)	(+ 11 (X4) (-) 12 (X4)	
	7	7A	7 (1st SAI143)	(+ 25 (CN1) (-) 26 (CN1)	(+ 25 (CN2) (-) 26 (CN2)	(+ 13 (X3) (-) 14 (X3)			
		7B	7 (2nd SAI143)	(+ 25 (CN3) (-) 26 (CN3)	(+ 25 (CN4) (-) 26 (CN4)	(+ 13 (X4) (-) 14 (X4)			
	8	8A	8 (1st SAI143)	(+ 23 (CN1) (-) 24 (CN1)	(+ 23 (CN2) (-) 24 (CN2)	(+ 15 (X3) (-) 16 (X3)			
		8B	8 (2nd SAI143)	(+ 23 (CN3) (-) 24 (CN3)	(+ 23 (CN4) (-) 24 (CN4)	(+ 15 (X4) (-) 16 (X4)			
	9	9A	9 (1st SAI143)	(+ 21 (CN1) (-) 22 (CN1)	(+ 21 (CN2) (-) 22 (CN2)	(+ 17 (X3) (-) 18 (X3)			
		9B	9 (2nd SAI143)	(+ 21 (CN3) (-) 22 (CN3)	(+ 21 (CN4) (-) 22 (CN4)	(+ 17 (X4) (-) 18 (X4)			
	10	10A	10 (1st SAI143)	(+ 19 (CN1) (-) 20 (CN1)	(+ 19 (CN2) (-) 20 (CN2)	(+ 19 (X3) (-) 20 (X3)			
		10B	10 (2nd SAI143)	(+ 19 (CN3) (-) 20 (CN3)	(+ 19 (CN4) (-) 20 (CN4)	(+ 19 (X4) (-) 20 (X4)			
	11	11A	11 (1st SAI143)	(+ 17 (CN1) (-) 18 (CN1)	(+ 17 (CN2) (-) 18 (CN2)	(+ 21 (X3) (-) 22 (X3)			
		11B	11 (2nd SAI143)	(+ 17 (CN3) (-) 18 (CN3)	(+ 17 (CN4) (-) 18 (CN4)	(+ 21 (X4) (-) 22 (X4)			
	12	12A	12 (1st SAI143)	(+ 15 (CN1) (-) 16 (CN1)	(+ 15 (CN2) (-) 16 (CN2)	(+ 23 (X3) (-) 24 (X3)			
		12B	12 (2nd SAI143)	(+ 15 (CN3) (-) 16 (CN3)	(+ 15 (CN4) (-) 16 (CN4)	(+ 23 (X4) (-) 24 (X4)			
13	13A	13 (1st SAI143)	(+ 13 (CN1) (-) 14 (CN1)	(+ 13 (CN2) (-) 14 (CN2)	(+ 25 (X3) (-) 26 (X3)				
	13B	13 (2nd SAI143)	(+ 13 (CN3) (-) 14 (CN3)	(+ 13 (CN4) (-) 14 (CN4)	(+ 25 (X4) (-) 26 (X4)				
14	14A	14 (1st SAI143)	(+ 11 (CN1) (-) 12 (CN1)	(+ 11 (CN2) (-) 12 (CN2)	(+ 27 (X3) (-) 28 (X3)				
	14B	14 (2nd SAI143)	(+ 11 (CN3) (-) 12 (CN3)	(+ 11 (CN4) (-) 12 (CN4)	(+ 27 (X4) (-) 28 (X4)				
15	15A	15 (1st SAI143)	(+ 9 (CN1) (-) 10 (CN1)	(+ 9 (CN2) (-) 10 (CN2)	(+ 29 (X3) (-) 30 (X3)				
	15B	15 (2nd SAI143)	(+ 9 (CN3) (-) 10 (CN3)	(+ 9 (CN4) (-) 10 (CN4)	(+ 29 (X4) (-) 30 (X4)				
16	16A	16 (1st SAI143)	(+ 7 (CN1) (-) 8 (CN1)	(+ 7 (CN2) (-) 8 (CN2)	(+ 31 (X3) (-) 32 (X3)				
	16B	16 (2nd SAI143)	(+ 7 (CN3) (-) 8 (CN3)	(+ 7 (CN4) (-) 8 (CN4)	(+ 31 (X4) (-) 32 (X4)				

Termination Board supply connection details:

