



INSTRUCTION & SAFETY MANUAL

SIL 2 Switch/Proximity Detector Repeater,
Relay Output DIN-Rail
Models D5036S, D5036D



Characteristics

General Description: The single and dual channel Switch/Proximity Detector Repeater, D5036S and D5036D module is a unit suitable for applications requiring SIL 2 level (according to IEC 61508:2010 Ed. 2) in safety related systems for high risk industries.

The unit can be configured for switch or proximity detector (EN60947-5-6, NAMUR), NO or NC and for NE or ND SPST (D5036D) or SPDT (D5036S) relay output contact. Each channel enables a Safe Area load to be controlled by a switch, or a proximity detector, located in Hazardous Area.

A fault detection circuit (DIP switch enabled) is available for both proximity sensor and switch equipped with end of line resistors. In case of fault, when enabled, it de-energizes the corresponding output relay and turns the fault LED on; when disabled the corresponding output relay repeats the input line open or closed status as configured.

Mounting on standard DIN-Rail, with or without Power Bus, in Safe Area / Non Hazardous Location or in Zone 2 / Class I, Division 2 or Class I, Zone 2.

Functional Safety Management Certification:

G.M. International is certified by TÜV to conform to IEC61508:2010 part 1 clauses 5-6 for safety related systems up to and included SIL3.



Technical Data

Supply: 24 Vdc nom (18 to 30 Vdc) reverse polarity protected, ripple within voltage limits ≤ 5 Vpp, 2 A time lag fuse internally protected.

Current consumption @ 24 V: 35 mA for 2 channels D5036D, 18 mA for 1 channel D5036S with short circuit input and relay energized, typical.

Power dissipation: 0.85 W for 2 channels D5036D, 0.45 W for 1 channel D5036S with 24 V supply voltage, short circuit input and relay energized, typical.

Isolation (Test Voltage): I.S. In/Out 1.5 KV; I.S. In/Supply 1.5 KV; I.S. In/ I.S In 500 V; Out/Supply 1.5 KV; Out/Out 1.5 KV.

Input switching current levels: ON ≥ 2.1 mA (1.9 to 6.2 mA range), OFF ≤ 1.2 mA (0.4 to 1.3 mA range), switch current ≈ 1.65 mA ± 0.2 mA hysteresis.

Fault current levels: open fault ≤ 0.2 mA, short fault ≥ 6.8 mA.

Input equivalent source: 8 V 1 K Ω typical (8 V no load, 8 mA short circuit).

Output: voltage free SPST (D5036D) or SPDT (D5036S) relay contact.

Contact material: Ag Alloy (Cd free), gold plated.

Contact rating: 4 A 250 Vac 1000 VA, 4 A 250 Vdc 120 W (resistive load). Min. switching current 1 mA.

DC Load breaking capacity:

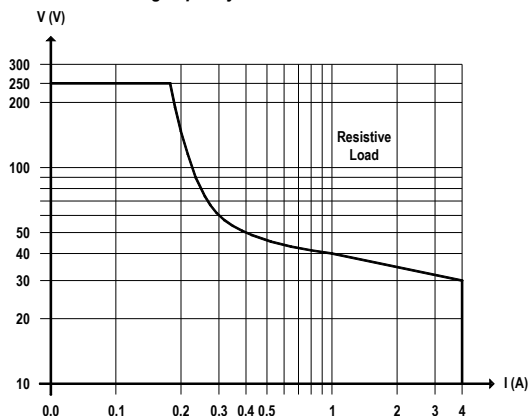

Mechanical / Electrical life: $5 * 10^6 / 3 * 10^4$ operation, typical.

Operate / Release time: 8 / 4 ms typical.

Bounce time NO / NC contact: 3 / 8 ms typical.

Frequency response: 10 Hz maximum.

Compatibility:

CE CE mark compliant, conforms to Directive: 2014/34/EU ATEX, 2014/30/EU EMC, 2014/35/EU LVD, 2011/65/EU RoHS.

Environmental conditions:

Operating: temperature limits -40 to $+70$ °C, relative humidity 95 %, up to 55 °C.

Storage: temperature limits -45 to $+80$ °C.

Max altitude: 2000 m a.s.l.

Safety Description:



ATEX: II 3(1)G Ex ec nC [ia Ga] IIC T4 Gc, II (1)D [Ex ia Da] IIIC, I (M1) [Ex ia Ma] I. **IECEX / INMETRO:** Ex ec nC [ia Ga] IIC T4 Gc, [Ex ia Da] IIIC, [Ex ia Ma] I, **UL:** NI / I / 2 / ABCD / T4, AIS / I, II, III / 1 / ABCDEFG, AEx nA nC [ia Ga] IIC T4 Gc. **C-UL:** NI / I / 2 / ABCD / T4, AIS / I, II, III / 1 / ABCDEFG, Ex nA nC [ia Ga] IIC T4 Gc

EAC-EX: 2Ex nA nC [ia Ga] IIC T4 Gc X, [Ex ia Da] IIIC X, [Ex ia Ma] I X

CCC: Ex ec nC [ia Ga] IIC T4 Gc; [Ex ia Ga] IIC; [Ex ia Da] IIIC

UKR TR n. 898: 2ExnAnCialICT4 X, Exial X

associated apparatus and non-sparking electrical equipment.

Uo/Voc = 10.5 V, Io/Isc = 22 mA, Po/Po = 56 mW at terminals 7-8, 9-10.

Um = 250 Vrms, -40 °C \leq Ta ≤ 70 °C.

Approvals:

BVS 10 ATEX E 113 X conforms to EN60079-0, EN 60079-7, EN60079-11, EN60079-15,

IECEX BVS 10.0072X conforms to IEC60079-0, IEC60079-7, IEC60079-11, IEC60079-15,

UL & C-UL E222308 conforms to UL913, UL 60079-0, UL60079-11, UL60079-15, ANSI/ISA 12.12.01 for UL

and CSA-C22.2 No.157-92, CSA-E60079-0, CSA-E60079-11, CSA-C22.2 No. 213 and CSA-E60079-15 for C-UL.

INMETRO DNV 13.0109 X conforms to ABNT NBR IEC60079-0, ABNT NBR IEC60079-7, ABNT NBR IEC60079-11, ABNT NBR IEC60079-15.

EAЭC RU C-IT.AA87.B.00765/21 conforms to GOST 31610.0, GOST 31610.11, GOST 31610.15.

CCC n. 2020322316000978 conforms to GB/T 3836.1, GB/T 3836.3, GB/T 3834.4, GB/T 3836.8

CLJ 16.0036 X conforms to DCTY 7113, GOCT 22782.5-78, DCTY IEC 60079-15.

TÜV Certificate No. C-IS-236198-04, SIL 2 conforms to IEC61508:2010 Ed. 2.

SIL 3 Functional Safety TÜV Certificate conforms to IEC61508:2010 Ed.2, for Management of Functional Safety.

DNV Type Approval Certificate No. TAA00001U0 and KR No.MIL20769-EL002 Certificates for maritime applications.

Mounting:

EN/IEC60715 TH 35 DIN-Rail, with or without Power Bus.

Weight: about 135 g D5036D, 120 g D5036S.

Connection: by polarized plug-in disconnect screw terminal blocks to accommodate terminations up to 2.5 mm².

Location: installation in Safe Area/Non Hazardous Locations or Zone 2, Group IIC T4 or Class I, Division 2, Group A,B,C,D, T4 or Class I, Zone 2, Group IIC, T4.

Protection class: IP 20.

Dimensions: Width 12.5 mm, Depth 123 mm, Height 120 mm.

Ordering Information

Model:	D5036	
1 channel		S
2 channels		D

Power Bus and DIN-Rail accessories:
 Connector JDFT049 Cover and fix MCHP196
 Terminal block male MOR017 Terminal block female MOR022

Front Panel and Features

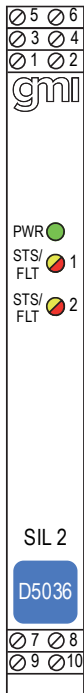

- SIL 2 according to IEC 61508:2010 Ed. 2 for Tproof = 4 / 20 years ($\leq 10\%$ / $> 10\%$ of total SIF) for D5036S and D5036D.
- PFDavg (1 year) 2.25 E-04, SFF 70.87 % for D5036S.
- PFDavg (1 year) 2.25 E-04, SFF 71.76 % for D5036D.
- Systematic capability SIL 3.
- Input from Zone 0 (Zone 20), installation in Zone 2.
- NO/NC switch/proximity Detector Input, NE/ND relay actuation mode.
- Field open and short circuit detection.
- Three port isolation, Input/Output/Supply.
- EMC Compatibility to EN61000-6-2, EN61000-6-4, EN61326-1, EN61326-3-1 for safety system.
- In-field programmability by DIP Switch.
- ATEX, IECEx, UL & C-UL, INMETRO, EAC-EX, CCC, UKR TR n. 898, TÜV Certifications.
- TÜV Functional Safety Certification.
- Type Approval Certificate DNV and KR for maritime applications.
- High Density, two channels per unit.
- Simplified installation using standard DIN-Rail and plug-in terminal blocks, with or without Power Bus.
- 250 Vrms (Um) max. voltage allowed to the instruments associated with the barrier.

Terminal block connections

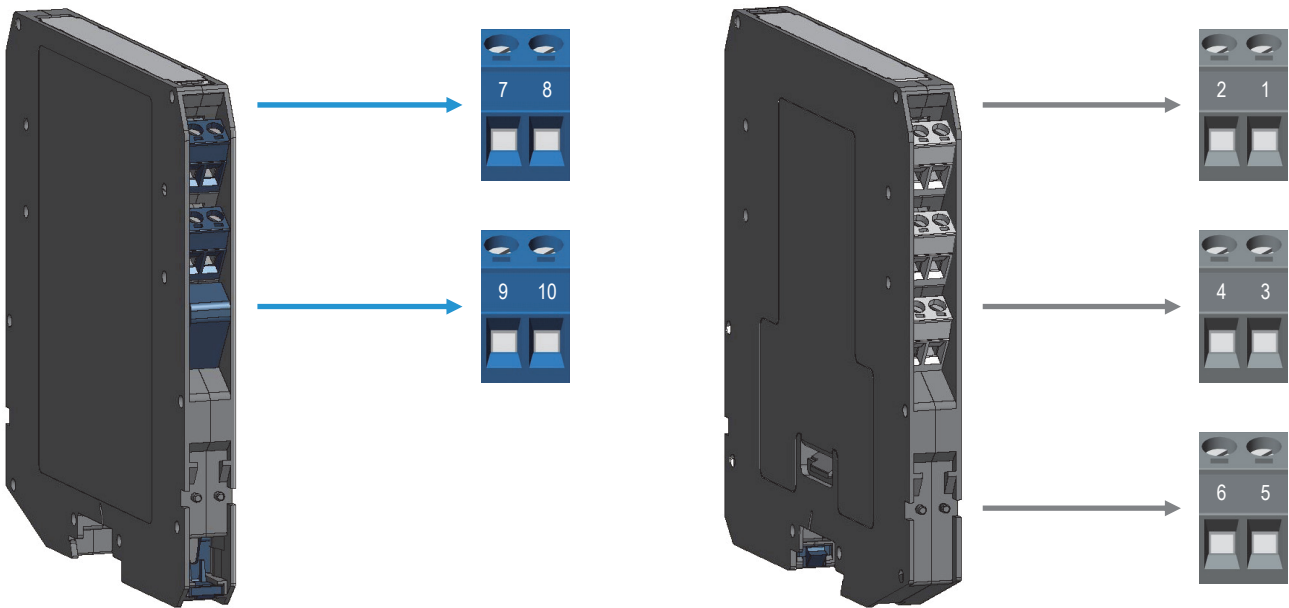

HAZARDOUS AREA

7	+ Input Ch 1 for Proximity or Voltage free Contact
8	- Input Ch 1 for Proximity or Voltage free Contact
9	+ Input Ch 2 for Proximity or Voltage free Contact
10	- Input Ch 2 for Proximity or Voltage free Contact

SAFE AREA

1	Output Ch 1
2	Output Ch 1
3	Output Ch 2
4	Output Ch 2
5	+ Power Supply 24 Vdc
6	- Power Supply 24 Vdc

Parameters Table

In the system safety analysis, always check the Hazardous Area/Hazardous Locations devices to conform with the related system documentation, if the device is Intrinsically Safe check its suitability for the Hazardous Area/Hazardous Locations and group encountered and that its maximum allowable voltage, current, power (U_i/V_{max} , I_i/I_{max} , P_i/P_i) are not exceeded by the safety parameters (U_o/V_{oc} , I_o/I_{sc} , P_o/P_o) of the D5036 series Associated Apparatus connected to it. Also consider the maximum operating temperature of the field device, check that added connecting cable and field device capacitance and inductance do not exceed the limits (C_o/C_a , L_o/L_a , L_o/R_o) given in the Associated Apparatus parameters for the effective group. See parameters indicated in the table below:

D5036 Terminals		D5036 Associated Apparatus Parameters		Must be	Hazardous Area/ Hazardous Locations Device Parameters
Ch1	7 - 8	$U_o / V_{oc} = 10.5 \text{ V}$		\leq	U_i / V_{max}
Ch2	9 - 10				
Ch1	7 - 8	$I_o / I_{sc} = 22 \text{ mA}$		\leq	I_i / I_{max}
Ch2	9 - 10				
Ch1	7 - 8	$P_o / P_o = 56 \text{ mW}$		\leq	P_i / P_i
Ch2	9 - 10				
D5036 Terminals		D5036 Associated Apparatus Parameters Cenelec (US)		Must be	Hazardous Area/ Hazardous Locations Device + Cable Parameters
Ch1	7 - 8	$C_o / C_a = 2.41 \mu\text{F}$	IIC (A, B)	\geq	$C_i / C_i \text{ device} + C \text{ cable}$
Ch2	9 - 10	$C_o / C_a = 16.8 \mu\text{F}$	IIB (C)		
		$C_o / C_a = 75 \mu\text{F}$	IIA (D)		
		$C_o / C_a = 66 \mu\text{F}$	I		
		$C_o / C_a = 16.8 \mu\text{F}$	IIIC (E, F, G)		
Ch1	7 - 8	$L_o / L_a = 78.3 \text{ mH}$	IIC (A, B)	\geq	$L_i / L_i \text{ device} + L \text{ cable}$
Ch2	9 - 10	$L_o / L_a = 313.4 \text{ mH}$	IIB (C)		
		$L_o / L_a = 626.9 \text{ mH}$	IIA (D)		
		$L_o / L_a = 1028.6 \text{ mH}$	I		
		$L_o / L_a = 313.4 \text{ mH}$	IIIC (E, F, G)		
Ch1	7 - 8	$L_o / R_o = 635 \mu\text{H}/\Omega$	IIC (A, B)	\geq	$L_i / R_i \text{ device and}$ $L \text{ cable} / R \text{ cable}$
Ch2	9 - 10	$L_o / R_o = 2543 \mu\text{H}/\Omega$	IIB (C)		
		$L_o / R_o = 5087 \mu\text{H}/\Omega$	IIA (D)		
		$L_o / R_o = 8347 \mu\text{H}/\Omega$	I		
		$L_o / R_o = 2543 \mu\text{H}/\Omega$	IIIC (E, F, G)		

For installations in which both the C_i and L_i of the Intrinsically Safe apparatus exceed 1% of the C_o and L_o parameters of the Associated Apparatus (excluding the cable), then 50% of C_o and L_o parameters are applicable and shall not be exceeded (50% of the C_o and L_o become the limits which must include the cable such that $C_i \text{ device} + C \text{ cable} \leq 50\% \text{ of } C_o$ and $L_i \text{ device} + L \text{ cable} \leq 50\% \text{ of } L_o$). The reduced capacitance of the external circuit (including cable) shall not be greater than $1 \mu\text{F}$ for Groups I, IIA, IIB and 600 nF for Group IIC. If the cable parameters are unknown, the following value may be used: Capacitance 200 pF per meter (60 pF per foot), Inductance $1 \mu\text{H}$ per meter ($0.20 \mu\text{H}$ per foot).

Function Diagram

HAZARDOUS AREA ZONE 0 (ZONE 20) GROUP IIC,
HAZARDOUS LOCATIONS CLASS I, DIVISION 1, GROUPS A, B, C, D,
CLASS II, DIVISION 1, GROUPS E, F, G, CLASS III, DIVISION 1,
CLASS I, ZONE 0, GROUP IIC

SAFE AREA, ZONE 2 GROUP IIC T4,
NON HAZARDOUS LOCATIONS, CLASS I, DIVISION 2,
GROUPS A, B, C, D T-Code T4, CLASS I, ZONE 2, GROUP IIC T4

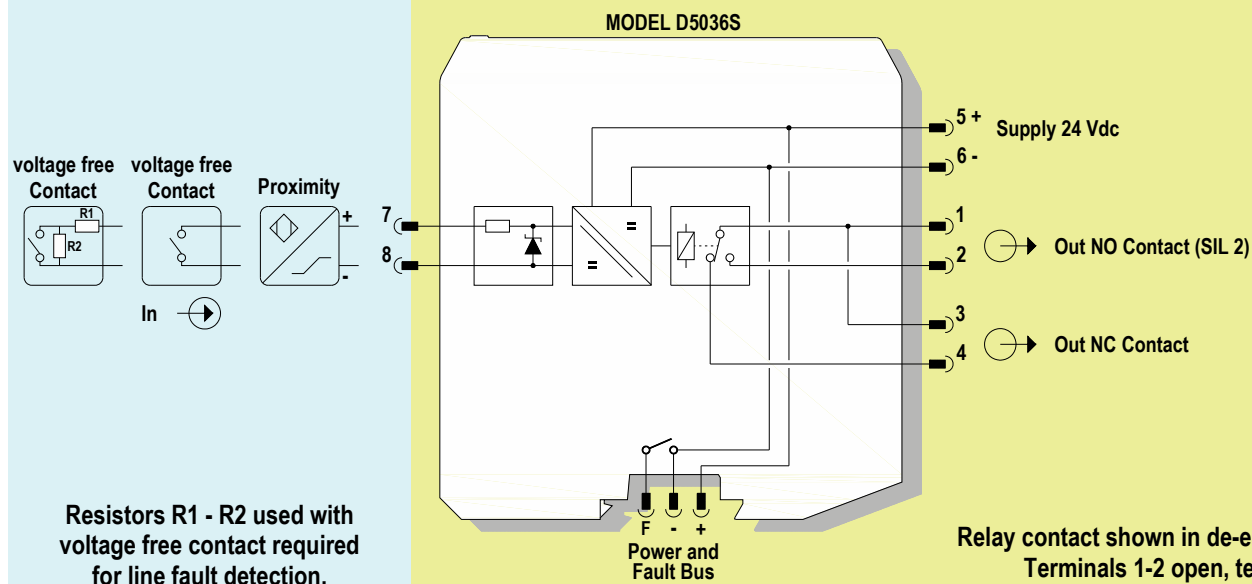
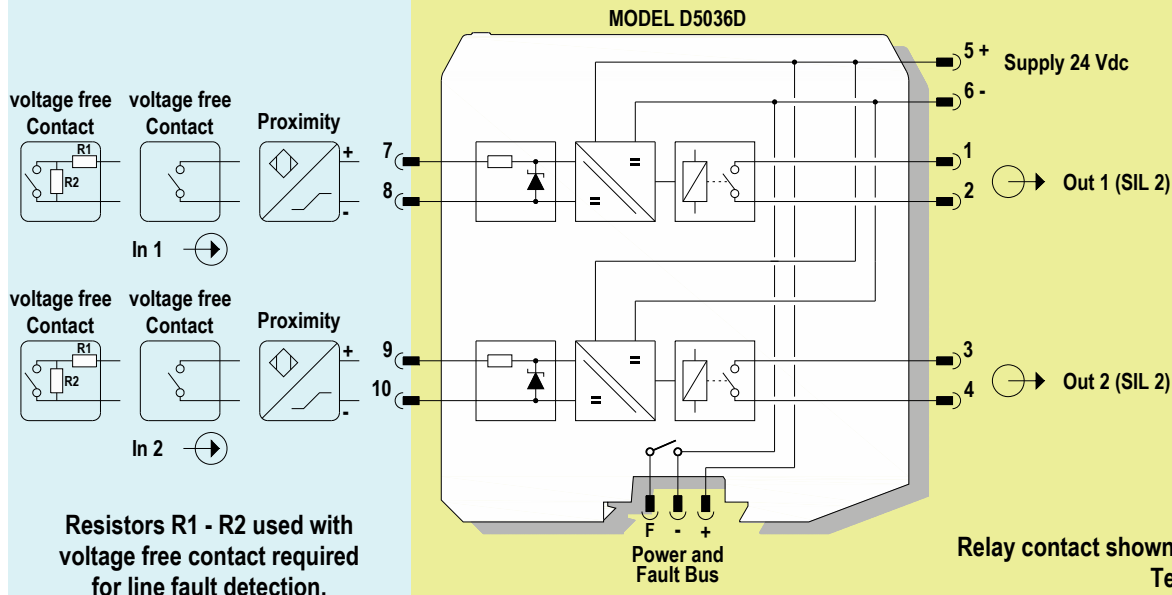

Application for D5036D

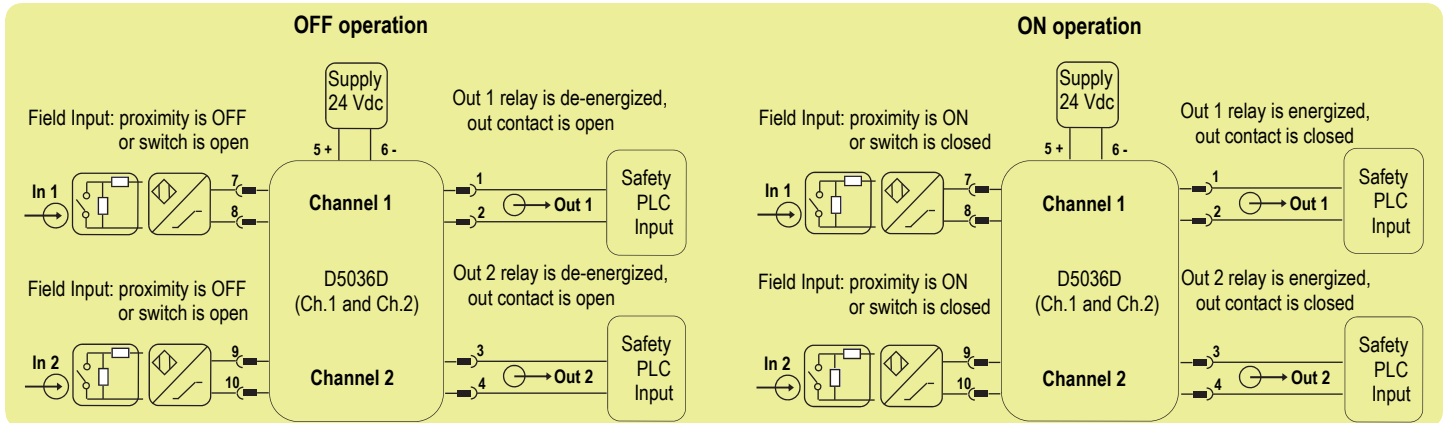

Description: For this application, enable input line fault (open or short) detection and direct input to output transfer function, by set the internal dip-switches in the following mode (see page 9 for more information):

Dip-switch position	1	2	3	4
ON/OFF state	ON	OFF	ON	OFF

The module is powered by connecting 24 Vdc power supply to Pins 5 (+ positive) - 6 (- negative). The green LED is lit in presence of supply power.

Input signals from field are applied to Pins 7-8 (In 1 - Ch.1) and Pins 9-10 (In 2 - Ch.2).

Relay contact outputs Pins 1-2 (for Channel 1) and Pins 3-4 (for Channel 2) are both normally open (or relay de-energized as safe state condition) for OFF operation, while they are both closed (or relay energized) for ON operation.

The following table describes for each channel the state (open or closed) of its output when its input signal is in OFF or ON state, and it gives information about turn-on or turn-off of the related channel status LED and channel fault LED:

Input signal state Pins 7-8 (In 1 - Ch.1) or 9-10 (In 2 - Ch.2)	Output relay contact state Pins 1-2 (Out 1 - Ch.1) or 3-4 (Out 2 - Ch.2)	Channel status yellow LED state	Channel fault red LED state
Proximity sensor is OFF or switch is open	Open (De-energize relay)	OFF	OFF
Proximity sensor is ON or switch is closed	Closed (Energized relay)	ON	OFF
Independently from proximity sensor or switch state, the input line is break	Open (De-energized relay as safe state condition)	OFF	ON
Independently from proximity sensor or switch state, the input line is in short circuit	Open (De-energized relay as safe state condition)	OFF	ON

Safety Function and Failure behavior:

D5036D is considered to be operating in Low Demand mode, as a Type A module, having Hardware Fault Tolerance (HFT) = 0.

The failure behavior is described from the following definitions :

- Fail-Safe State: it is defined as the relay output being de-energized (so that the NO contact is open);
- Fail Safe: failure mode that causes the module / (sub)system to go to the defined Fail-Safe state without a demand from the process;
- Fail Dangerous: failure mode that does not respond to a demand from the process (i.e. being unable to go to the defined Fail-Safe state), so that the relay output remains energized (the NO contact is blocked in closed position);
- Fail "No Effect": failure mode of a component that plays a part in implementing the Safety Function but that is neither a safe failure nor a dangerous failure.
When calculating the SFF, this failure mode is not taken into account;
- Fail "Not part": failure mode of a component that is not part of the Safety Function but that is part of the circuit diagram and is listed for completeness.
When calculating the SFF, this failure mode is not taken into account.

The 2 channels of D5036D module must not be used to increase the hardware fault tolerance, needed for a higher SIL of a certain Safety Function, as they are not completely independent each other, containing common components.

Failure rate data: taken from Siemens Standard SN29500.

Failure rate table:

Failure category	Failure rates (FIT)
λ_{dd} = Total Dangerous Detected failures	0.00
λ_{du} = Total Dangerous Undetected failures	51.22
λ_{sd} = Total Safe Detected failures	0.00
λ_{su} = Total Safe Undetected failures	130.16
$\lambda_{tot\ safe}$ = Total Failure Rate (Safety Function) = $\lambda_{dd} + \lambda_{du} + \lambda_{sd} + \lambda_{su}$	181.38
MTBF (safety function, one channel) = $(1 / \lambda_{tot\ safe}) + MTTR$ (8 hours)	629 years
$\lambda_{no\ effect}$ = "No Effect" failures	138.62
$\lambda_{not\ part}$ = "Not Part" failures	200.20
$\lambda_{tot\ device}$ = Total Failure Rate (Device) = $\lambda_{tot\ safe} + \lambda_{no\ effect} + \lambda_{not\ part}$	520.20
MTBF (device, one channel) = $(1 / \lambda_{tot\ device}) + MTTR$ (8 hours)	219 years

Failure rates table according to IEC 61508:2010 Ed.2 :

λ_{sd}	λ_{su}	λ_{dd}	λ_{du}	SFF
0.00 FIT	130.16 FIT	0.00 FIT	51.22 FIT	71.76%

PFDavg vs T[Proof] table (assuming Proof Test coverage of 99%), with determination of SIL supposing module contributes ≤10% of total SIF dangerous failures:

T[Proof] = 1 year	T[Proof] = 4 years
PFDavg = 2.25 E-04 Valid for SIL 2	PFDavg = 8.99 E-04 Valid for SIL 2

PFDavg vs T[Proof] table (assuming Proof Test coverage of 99%), with determination of SIL supposing module contributes >10% of total SIF dangerous failures:

T[Proof] = 20 years
PFDavg = 4.50 E-03 Valid for SIL 2

Systematic capability SIL 3.

Application for D5036S

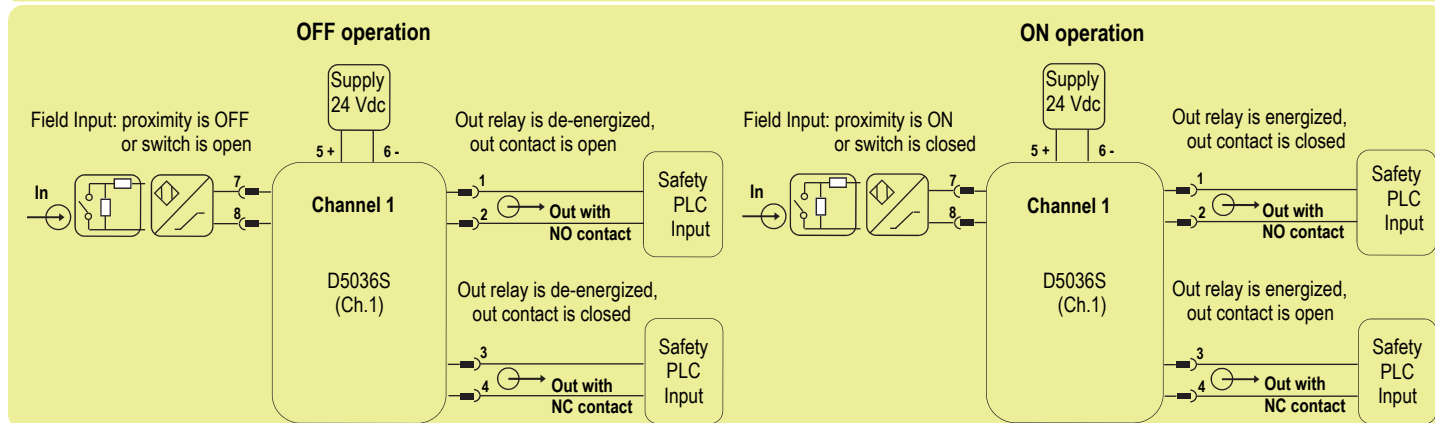

Description:

For this application, enable input line fault (open or short) detection and direct input to output transfer function, by set the internal dip-switches in the following mode (see page 10 for more information):

Dip-switch position	1	2	3	4
ON/OFF state	ON	OFF	Not used	Not used

The module is powered by connecting 24 Vdc power supply to Pins 5 (+ positive) - 6 (- negative). The green LED is lit in presence of supply power.

Input signal from field is applied to Pins 7-8 (In 1 - Ch.1).

Relay contact output Pins 1-2 is normally open or Pins 3-4 is normally closed (because relay is de-energized as safe state condition) for OFF operation, while Pins 1-2 is closed or Pins 3-4 is open (because relay is energized) for ON operation. The following table describes for Channel 1 the state (open or closed) of its output contacts when its input signal is in OFF or ON state, and it gives information about turn-on or turn-off of its channel status LED and channel fault LED:

Input signal state Pins 7-8	Out relay contact state Pins 1-2 (with NO contact)	Out relay contact state Pins 3-4 (with NC contact)	Channel status yellow LED state	Channel fault red LED state
Proximity is OFF or switch is open	Open (De-energize relay)	Closed (De-energize relay)	OFF	OFF
Proximity is ON or switch is closed	Closed (Energized relay)	Open (Energized relay)	ON	OFF
If the input line is break	Open (safe state condition)	Closed (safe state condition)	OFF	ON
If the input line is in short circuit	Open (safe state condition)	Closed (safe state condition)	OFF	ON

Safety Function and Failure behavior:

D5036S is considered to be operating in Low Demand mode, as a Type A module, having Hardware Fault Tolerance (HFT) = 0.

The failure behavior is described from the following definitions :

- Fail-Safe State: it is defined as the relay output being de-energized (so that the NO contact is open and the NC contact is closed);
- Fail Safe: failure mode that causes the module / (sub)system to go to the defined Fail-Safe state without a demand from the process;
- Fail Dangerous: failure mode that does not respond to a demand from the process (i.e. being unable to go to the defined Fail-Safe state), so that the relay output remains energized (the NO contact is blocked in closed position and the NC contact is blocked in open position);
- Fail "No Effect": failure mode of a component that plays a part in implementing the Safety Function but that is neither a safe failure nor a dangerous failure. When calculating the SFF, this failure mode is not taken into account;
- Fail "Not part": failure mode of a component that is not part of the Safety Function but that is part of the circuit diagram and is listed for completeness. When calculating the SFF, this failure mode is not taken into account.

Failure rate data: taken from Siemens Standard SN29500.

Failure rate table:

Failure category	Failure rates (FIT)
λ_{dd} = Total Dangerous Detected failures	0.00
λ_{du} = Total Dangerous Undetected failures	51.22
λ_{sd} = Total Safe Detected failures	0.00
λ_{su} = Total Safe Undetected failures	124.62
$\lambda_{tot\ safe}$ = Total Failure Rate (Safety Function) = $\lambda_{dd} + \lambda_{du} + \lambda_{sd} + \lambda_{su}$	175.84
MTBF (safety function, one channel) = $(1 / \lambda_{tot\ safe}) + MTTR$ (8 hours)	649 years
$\lambda_{no\ effect}$ = "No Effect" failures	128.26
$\lambda_{not\ part}$ = "Not Part" failures	23.50
$\lambda_{tot\ device}$ = Total Failure Rate (Device) = $\lambda_{tot\ safe} + \lambda_{no\ effect} + \lambda_{not\ part}$	327.60
MTBF (device, one channel) = $(1 / \lambda_{tot\ device}) + MTTR$ (8 hours)	348 years

Failure rates table according to IEC 61508:2010 Ed.2 :

λ_{sd}	λ_{su}	λ_{dd}	λ_{du}	SFF
0.00 FIT	124.62 FIT	0.00 FIT	51.22 FIT	70.87%

PFDavg vs T[Proof] table (assuming Proof Test coverage of 99%), with determination of SIL supposing module contributes $\leq 10\%$ of total SIF dangerous failures:

T[Proof] = 1 year	T[Proof] = 4 years
PFDavg = 2.25 E-04 Valid for SIL 2	PFDavg = 8.99 E-04 Valid for SIL 2

PFDavg vs T[Proof] table (assuming Proof Test coverage of 99%), with determination of SIL supposing module contributes $> 10\%$ of total SIF dangerous failures:

T[Proof] = 20 years
PFDavg = 4.50 E-03 Valid for SIL 2

Systematic capability SIL 3.

Testing procedure at T-proof

The proof test shall be performed to reveal dangerous faults which are undetected by diagnostic. This means that it is necessary to specify how dangerous undetected fault, which have been noted during the FMEDA, can be revealed during proof test.

Note for switch input: to detect a broken wire, or a short circuit condition, in the input connections it is necessary to mount, close to the switches, the end of line resistors: R1=1 k Ω typical (470 Ω to 2 k Ω range) resistor in series and R2=10 k Ω typical (5 k Ω to 15 k Ω range) resistor in parallel to the contacts.

The Proof test consists of the following steps:

Steps	Action
1	Bypass the Safety-related PLC or take any other appropriate action in order to avoid a false trip.
2	Vary the state conditions of the input sensors/contacts coming from field and verify that the relay outputs change from de-energized to energized and vice versa; then, check that the de-energized state condition corresponds to the required Safety-related function.
3	If input line fault detection is enabled for each channel by means of a dip-switches specific set up, disconnect the input wiring coming from the field sensor/contact and check that the correspondent relay output is de-energized. Then, put in short circuit condition the input connections and verify that the same output remains de-energized. In both cases, the related red alarm LEDs on the front panel will be turned on.
4	Restore the loop to full operation.
5	Remove the bypass from the safety-related PLC or restore normal operation.

This test will reveal approximately 99 % of possible Dangerous Undetected failures in the repeater.

Warning

D5036 series are isolated Intrinsically Safe Associated Apparatus installed into standard EN/IEC60715 TH 35 DIN-Rail located in Safe Area or Zone 2, Group IIC, Temperature T4, Hazardous Area within the specified operating temperature limits Tamb -40 to +70 °C, and connected to equipment with a maximum limit for AC power supply Um of 250 Vrms. Not to be connected to control equipment that uses or generates more than 250 Vrms or Vdc with respect to earth ground.

D5036 series must be installed, operated and maintained only by qualified personnel, in accordance to the relevant national/international installation standards (e.g. IEC/EN60079-14 Electrical apparatus for explosive gas atmospheres - Part 14: Electrical installations in hazardous areas (other than mines)), following the established installation rules, particular care shall be given to segregation and clear identification of I.S. conductors from non I.S. ones.

De-energize power source (turn off power supply voltage) before plug or unplug the terminal blocks when installed in Hazardous Area or unless area is known to be nonhazardous.

Warning: substitution of components may impair Intrinsic Safety and suitability for Zone 2.

Explosion Hazard: to prevent ignition of flammable or combustible atmospheres, disconnect power before servicing or unless area is known to be nonhazardous.

Failure to properly installation or use of the equipment may risk to damage the unit or severe personal injury.

The unit cannot be repaired by the end user and must be returned to the manufacturer or his authorized representative.

Any unauthorized modification must be avoided.

Operation

D5036 module is a unit suitable for applications requiring SIL 2 level (according to IEC 61508) in safety related systems for high risk industries.

The unit can be configured for switch or proximity detector (EN60947-5-6, NAMUR), NO or NC and for NE or ND SPST (D5036D) or SPDT (D5036S) relay output contact.

Each channel enables a Safe Area load to be controlled by a switch, or a proximity detector, located in Hazardous Area.

Fault detection circuit (DIP switch configurable) is available for both proximity sensors and switch equipped with end of line resistors. In case of fault, when enabled it de-energizes the corresponding output relay and turns the fault LED on; when disabled the corresponding output relay repeats the input line open or closed status as configured.

In case of fault output, relay actuation can be programmed as normally energized or normally de-energized.

Presence of supply power and status of output (energized or de-energized), as well as integrity or fault condition of sensor and connecting line are displayed by signaling LEDs (green for power, yellow for status and red for fault condition).

Note: use of voltage free electrical contacts with fault detection enabled (control equipment) requires, near the switch at the end of the line a R1=1 k Ω typical (470 Ω to 2 k Ω range) resistor in series and a R2=10 k Ω typical (5 k Ω to 15 k Ω range) resistor in parallel to the contacts in order to allow the fault detection circuit to distinguish between a condition of contact close/open and a line open/short circuit fault.

Installation

D5036 series are Switch/Proximity Detector Interface housed in a plastic enclosure suitable for installation on EN/IEC60715 TH 35 DIN-Rail, with or without Power Bus.

D5036 series can be mounted with any orientation over the entire ambient temperature range.

Electrical connection are accommodated by polarized plug-in removable screw terminal blocks which can be plugged in/out into a powered unit without suffering or causing any damage **(for Zone 2 installations check the area to be nonhazardous before servicing)**. Connect only one individual conductor per each clamping point, use conductors up to 2.5 mm² (13 AWG) and a torque value of 0.5-0.6 Nm. The wiring cables have to be proportionate in base to the current and the length of the cable.

In case of installation in zone 2, the connecting cables of non-intrinsically safe circuits must be safely routed in a cable duct or similar. The distance between the pluggable connection terminal and the cable duct should not exceed 500 mm cable length.

On the section "Function Diagram" and enclosure side a block diagram identifies all connections.

Identify the number of channels of the specific card (e.g. D5036S is a single channel model and D5036D is a dual channel model), the function and location of each connection terminal using the wiring diagram on the corresponding section, as an example:

Connect 24 Vdc power supply positive at terminal "5" and negative at terminal "6".

For Model D5036S connect output of channel 1 at terminals "1" and "2".

For Model D5036D in addition to channel 1 connections above, connect output of channel 2 at terminals "3" and "4".

For Model D5036S, in case of Proximity or Voltage free Contact, connect the wires at terminal "7" for positive and "8" for negative.

For Model D5036D in addition to channel 1 connections above, connect terminal "9" for positive and "10" for negative on channel 2.

Intrinsically Safe conductors must be identified and segregated from non I.S. and wired in accordance to the relevant national/international installation standards (e.g. EN/IEC60079-14 Electrical apparatus for explosive gas atmospheres - Part 14: Electrical installations in hazardous areas (other than mines)), make sure that conductors are well isolated from each other and do not produce any unintentional connection. Connect SPDT (D5036S) or SPST (D5036D) relay contacts checking the load rating to be within the contact maximum rating (4 A 250 Vac 1000 VA, 4 A 250 Vdc 120 W resistive load). **If necessary, to prevent relay contacts from damaging, an external protection (fuse or similar) should be connected. A suitable protection must be chosen according to the relay breaking capacity diagram on data sheet.**

The enclosure provides, according to EN60529, an IP20 minimum degree of protection (or similar to NEMA Standard 250 type 1). The equipment shall only be used in an area of at least pollution degree 2, as defined in IEC 60664-1. When installed in EU Zone 2, the unit shall be installed in an enclosure that provides a minimum ingress protection of IP54 in accordance with IEC 60079-0. When installed in a Class I, Zone 2 Hazardous Location, the unit shall be mounted in a supplemental AEx or Ex enclosure that provides a degree of protection not less than IP54 in accordance with UL/CSA 60079-0. When installed in a Class I, Division 2 Hazardous Location, the unit shall be mounted in a supplemental enclosure that provides a degree of protection not less than IP54. The enclosure must have a door or cover accessible only by the use of a tool. The end user is responsible to ensure that the operating temperature of the module is not exceeded in the end use application.

Units must be protected against dirt, dust, extreme mechanical (e.g. vibration, impact and shock) and thermal stress, and casual contacts.

If enclosure needs to be cleaned use only a cloth lightly moistened by a mixture of detergent in water.

Electrostatic Hazard: to avoid electrostatic hazard, the enclosure of D5036 must be cleaned only with a damp or antistatic cloth.

Any penetration of cleaning liquid must be avoided to prevent damage to the unit. Any unauthorized card modification must be avoided.

D5036 series must be connected to SELV or PELV supplies. All circuits connected to D5036 series must comply with the overvoltage category II (or better) according to EN/IEC60664-1.

Warning: de-energize main power source (turn off power supply voltage) and disconnect plug-in terminal blocks before opening the enclosure to avoid electrical shock when connected to live hazardous potential.

Start-up

Before powering the unit check that all wires are properly connected, particularly supply conductors and their polarity, input and output wires, also check that Intrinsically Safe conductors and cable trays are segregated (no direct contacts with other non I.S. conductors) and identified either by color coding, preferably blue, or by marking. Check conductors for exposed wires that could touch each other causing dangerous unwanted shorts. Turn on power, the "power on" green led must be lit, status and fault led on each channel must be in accordance with condition of the corresponding input line. If possible close and open input lines one at time checking the corresponding status and fault leds condition as well as output to be correct.

D5036D

A configuration DIP switch is located on component side of pcb. This switch allows the configuration of input/output relationship, fault detection functions and operating mode.

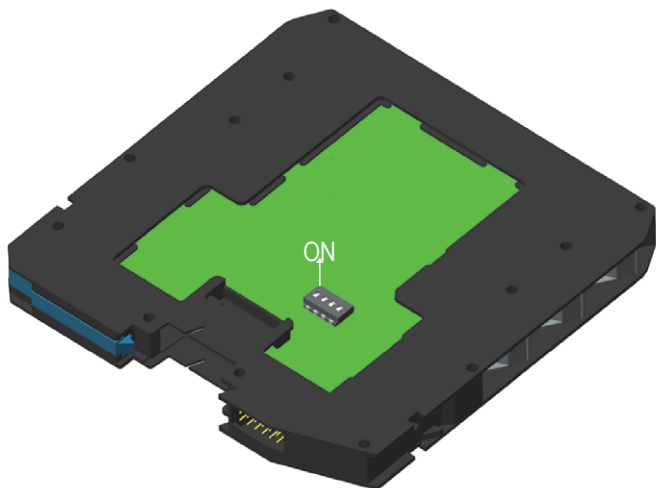

Dip switch factory settings. All Switches are OFF

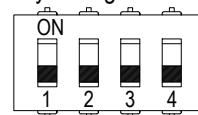

Dip switch configuration

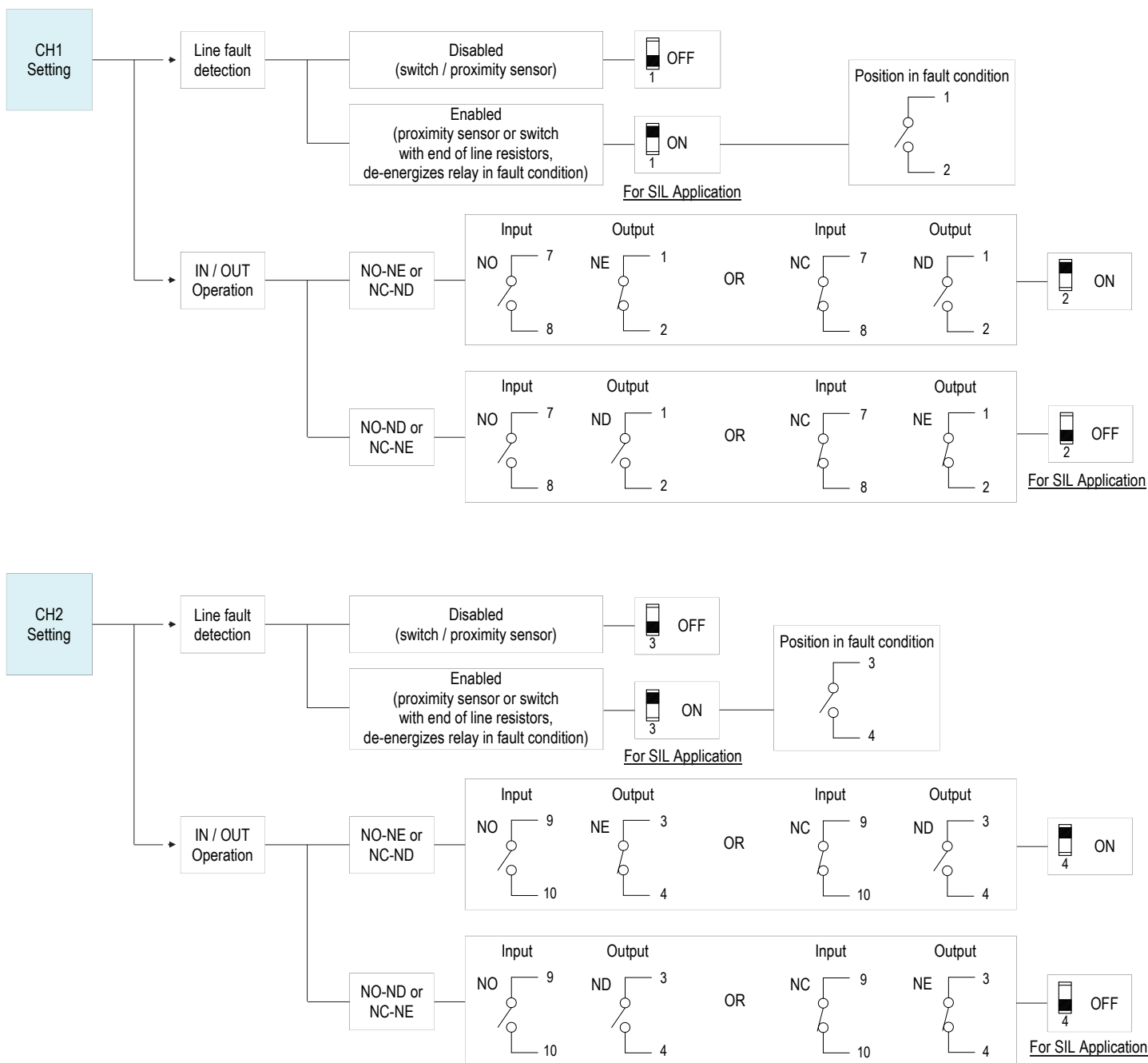
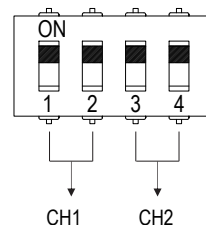

Configuration

D5036S

A configuration DIP switch is located on component side of pcb. This switch allows the configuration of input/output relationship, fault detection functions and operating mode.

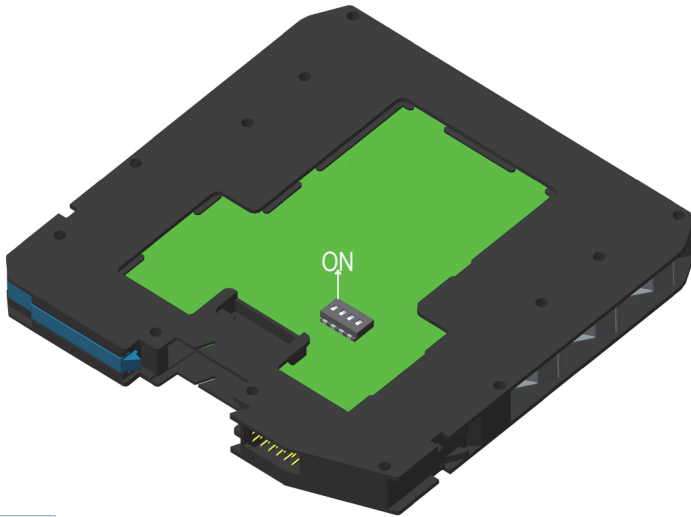

Dip switch factory settings. All Switches are OFF

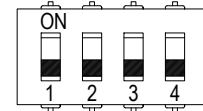

Dip switch configuration

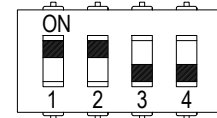

CH1 3-4 not used

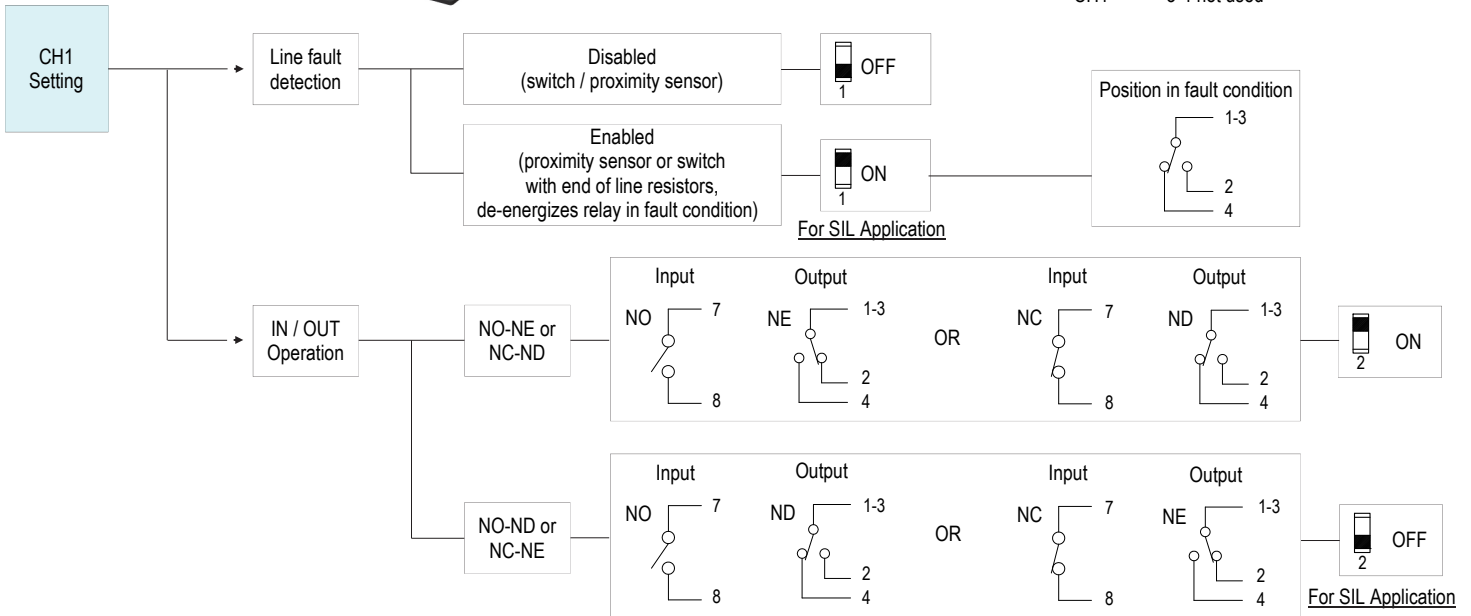

Configuration

DIP Switch factory settings (valid for D5036S and D5036D)

SW1	SW2	SW3	SW4
OFF	OFF	OFF	OFF

Note: SW3 and SW4 used only in D5036D.

D5036D Configuration Summary Table

Channel	1	2
Line fault detection	SW1	SW3
Disabled (switch/proximity sensor)	OFF	OFF
Enabled, for SIL application (proximity sensor or switch with end of line resistors, detects field open circuit and short circuit, de-energizes relay in fault condition)	ON	ON

Channel	1	2
IN/OUT Operation	SW2	SW4
NO-NE or NC-ND	ON	ON
NO-ND or NC-NE (for SIL application)	OFF	OFF

D5036S Configuration Summary Table

Line fault detection	SW1
Disabled (switch/proximity sensor)	OFF
Enabled, for SIL application (proximity sensor or switch with end of line resistors, detects field open circuit and short circuit, de-energizes relay in fault condition)	ON

IN/OUT Operation	SW2
NO-NE or NC-ND	ON
NO-ND or NC-NE (for SIL application)	OFF

Note: SW3 and SW4 not used.