



INSTRUCTION & SAFETY MANUAL

SIL 3 Power Supply System PSS1250(-HS)-7-48-D
48 Vdc - 50 A,
19" Rack with 4 power modules PSM1250
and diagnostic module PSO1250



G.M. International s.r.l.
20852 Villasanta MB Italy

SIL 3 Power Supply System PSS1250(-HS)-7-48-D 48 Vdc - 50 A 19" Rack with 4 power modules PSM1250 and diagnostic module PSO1250

General Characteristics	3
Technical Data	3
PSO1250 supply information	3
Features	4
Ordering Information	4
Hot Swapping capability	5
Active Ideal Diode-OR circuit	6
Output voltage setting, Fault indications, Diagnostic information	6
Warning	6
Storage	6
Disposal	6
Functional Diagram for PSS1250-HS-7-48-D or PSS1250-7-48-D	7
Functional Safety Manual and Applications (for models with HS)	8
Functional Safety Manual and Applications (for models without HS)	10
Testing procedure at T-Proof	12
System Composition	12
Installation Procedure - 1st step - Back Panel installation for PSS1250-xx-7-48-D-W (wall mounting into a cabinet)	12
Installation Procedure - 2nd step - Wiring of AC input lines, faults, modbus terminal blocks on Back Panel PCB (PSS1250-xx-7-48-D)	13
Installation Procedure - 3rd step - Rack unit installation on Back Plane for PSS1250-xx-7-48-D-W (wall mounting into a cabinet)	14
- Installation of PSS1250-xx-7-48-D-F (frontal rack mounting into a cabinet)	15
Installation Procedure - 4th step (for models with HS) - Section A : HS setup	16
- Section B : Installation & start up of PSO1250	17
- Section C : HSC red LED signalling test	17
- Section D : Installation and pre-start up of PSM1250	18
- Section E : Wiring of 1st&2nd PSM1250 negative DC out lines	19
- Section F : Wiring of 5th&6th PSM1250 positive DC out lines & PSS start-up	20
Installation Procedure - 4th step (for models without HS) - Section A: Installation & start up of PSO1250	21
- Section B: Installation and pre-start up of PSM1250	22
- Section C: Wiring of 1st&2nd PSM1250 negative DC out lines	23
- Section D: Wiring of 5th&6th PSM1250 positive DC out lines & PSS start-up	24
Shutdown and Disconnecting Procedure of PSM1250 power module from the Rack unit: - for models with HS	25
- for models without HS	25
Replacement Procedure of PSM1250 power module from the Rack unit (for models with or without HS)	25
PSO1250 Diagnostic Module: features and set up	26
Supported Modbus parameters: functions and details	31

General characteristics

General Description:

The Power Supply System type PSS1250(-HS)-7-48-D is an anodized aluminum 19" Rack unit (4U high) suitable for 4 plug-in Power Supply Modules type PSM1250 and 1 Overview module type PSO1250 for diagnostic functions. Four PSM1250 are divided in two groups and each group is composed by 2 PSM1250 with paralleled outputs and with load sharing circuits which distribute current load equally to each PSM1250 to increase reliability and reduce internal power dissipation. Therefore, each group provides 24Vdc and 50 A output with redundancy. Two groups have their outputs connected in series by internal copper bar, therefore PSS1250(-HS)-7-48-D system provides 48Vdc and 50 A output with redundancy. The system accepts up to two independent AC power sources with nominal voltage range 110 to 240 Vac ($\pm 10\%$). Four configurations of 19" Rack Units are available with or without Hot Swapping: two for wall mounting and two for frontal rack mounting, always into a cabinet. For more information about different configurations see page 4.

Hot Swap Plug-ins:

When using rack PSS1250-HS-7-48-D, each PSM1250 power supply module can be placed without disturbing Power Supply operations.

Diagnostic:

Rack PSS1250(-HS)-7-48-D, accept a plugin module (PSO1250) dedicated to monitoring all diagnostic functions of each power supply, via a front panel touch screen LCD color display which indicates Input/Output Voltage, Current and Power; Input Line Frequency; Output current sharing percentage related to each group; Internal Temperature; alarm status. RS485 Modbus output provides full diagnostic and status conditions. PSO1250 presence or fault does not affect PSS1250 operation and functional safety application.

Overvoltage protection:

Each PSM1250 module has got 3 independent overvoltage protections: 1 voltage limiting loop at 30 Vdc and 1+1 crowbars at 30 Vdc. Therefore, PSS1250(-HS)-7-48-D system has 60 Vdc upper limit as maximum overvoltage protection value, considering series connection between overvoltage protections of both PSM1250 module groups.

EMC:

Fully compliant with CE marking applicable requirements.

High load fuses breaking capability:

In case of short circuit on the load, the Power supply system delivers a very high peak current (about 800 Amp) for a duration of 0.5 ms. This characteristic ensures the instant breakage of the protective fuse or circuit breaker. Because of the very short peak current duration, other equipment connected to the load are not affected by the failure event and continue to operate without interruption.

Functional Safety Management Certification:

G.M. International is certified by TUV to conform to IEC61508:2010 part 1 clauses 5-6 for safety related systems up to and included SIL3.



Technical Data

Supply:

AC Input voltage: nominal 110 to 240 Vac ($\pm 10\%$), with frequency range 48 to 62 Hz.
Power Factor Correction (full load): 0.95 typ.@230Vac, 0.99 typ.@115Vac, 4 PSMs ; 0.98 typ.@230Vac, 0.995 typ.@115Vac, only 2 PSMs: 1st & 5th OR 2nd & 6th.
Efficiency @48Vdc out (full load): $\geq 85\%$ @ 230 Vac, $\geq 82.5\%$ @ 115 Vac, 4 PSMs ; $\geq 89\%$ @ 230 Vac, $\geq 86\%$ @ 115 Vac, only 2 PSMs: 1st & 5th OR 2nd & 6th.
Max. internal power dissipation @48Vdc out (full load): 425 W @ 230 Vac, 505 W @ 115 Vac, 4 PSMs ;
305 W @ 230 Vac, 395 W @ 115 Vac, only 2 PSMs: 1st & 5th OR 2nd & 6th.

AC input current (sinusoidal at full load) @48Vdc out: 30 A @ 100Vac, 25.7 A @ 115 Vac, 13 A @ 230 Vac, 4 PSMs ;
28.4A @ 100Vac, 24.4 A @ 115 Vac, 12.1 A @ 230 Vac, only 2 PSMs: 1st & 5th OR 2nd & 6th.

Inrush current (each PSM): 37Apk @ 264Vac; 32Apk @ 230Vac; 16Apk @ 115Vac.
AC input connection: screw terminal blocks suitable for 4mm² wires on back panel pcb.

Isolation (Test Voltage):

Input to Output isolation: 2500 Vrms (routine test).
Input to Earth-Ground isolation: 1500 Vrms (routine test).
Earth-Ground to Output isolation: 500 Vrms (routine test).
Output or Earth-Ground to Fault contact isolation: 500 Vrms (routine test)

Output:

Output voltage: 48 Vdc (adjustable from 42 to 56 Vdc) for whole system. Each PSM1250 output is 24 Vdc (adjustable from 21 to 28 Vdc).
Regulation: 0.4 % for a 100 % load change.
Stability: 0.01 % for a 20 % line voltage change.
Ripple: ≤ 250 mVpp.

Output current (@48Vdc out): 50 A nominal.
Output power: up to 2400 W nominal (@48Vdc out), max 2600 W nominal (@56Vdc out).
Output Rise Time: 2.5 s.

Dynamic Response: 2 ms for 0-100% load change (overshoot $\pm 1.5\%$ of Vout setting).
Connection: M6 screw terminals on copper bars suitable for lug (at least 6.5 mm hole diameter) with 16mm² wire on back panel pcb.
Hold-up time (AC in) at full load: 40ms (4 PSMs), 20ms (only 2 PSMs: 1st & 5th OR 2nd & 6th).
Over voltage protection: each PSM1250 output is limited to 30 Vdc plus two redundant crowbars for over voltage protection at 30 Vdc. Therefore, PSS1250(-HS)-7-48-D output is upper limited to 60 Vdc maximum value.

Power good signaling:

Output good: $19.5\text{ V} \leq \text{Vout} \leq 29.5\text{ V}$ (see page 6 for more information).
Indication: via LCD touch screen on PSO1250 and Modbus RTU RS-485 protocol.
Signaling: voltage free SPST normally energized relay (contact closed), de-energize in over/under voltage conditions (contact open).
Contact Rating: 2 A 50 Vac 100 VA, 2 A 24 Vdc 48 W (resistive load).
Connection: screw terminal blocks suitable for 1.5 mm² wires on back panel pcb.

Compatibility:

 CE mark compliant, conforms to Directive: 2014/30/EU EMC, 2014/35/EU LVD, 2011/65/EU RoHS.

Environmental conditions:

Operating temperature limits: -40 to +70°C de-rated linearly 65-70% load above 50°C (see on next page the Power Output vs. Ambient Operating Temperature diagram).
Relative humidity limits: 95 %, up to 55 °C.
Transport, storage temperature limits: - 45 to + 85 °C. **Max altitude:** 2000 m a.s.l.

Approvals:

SIL 3 / SIL 2 conform to IEC 61508:2010 Ed. 2.
SIL 3 Functional Safety TÜV Certificate conforms to IEC61508:2010 Ed.2, for Management of Functional Safety.

Mechanical:

Mounting: 19" Rack unit for wall mounting or for frontal rack mounting, into a cabinet.
Weight: 19" fully equipped about 20 Kg, with 4 PSM1250 and 1 PSO1250 module.
Location: installation in Safe Area/Non Hazardous Locations.
Protection class: IP 20, Open Type.
Dimensions: see drawings on pages 12, 14 and 15.

PSO1250 supply information

Supply:



AC Input voltage (each AC terminal block): nominal 110 to 240 Vac ($\pm 10\%$), with frequency range 48 to 62 Hz.
AC input current (sinusoidal): 45 mA @ 100 Vac input voltage, 40 mA @ 115 Vac input voltage, 15 mA @ 230 Vac input voltage.
Inrush current: 1.6 A peak @ 264 Vac; 1.4 A peak @ 230 Vac; 0.7 A peak @ 115 Vac.

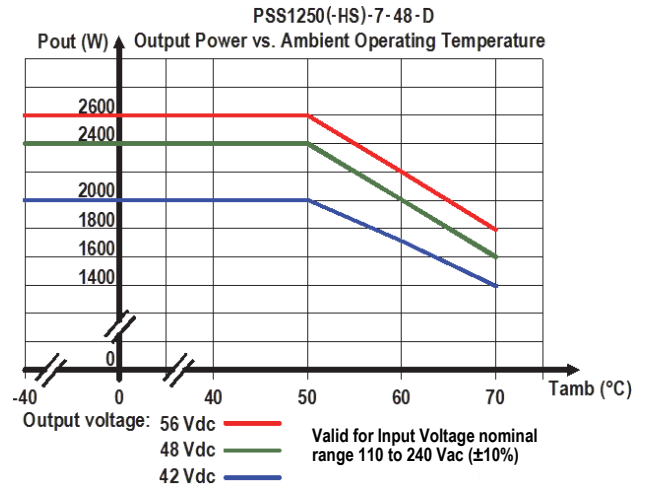

Features

- SIL 3 for NE Load according IEC 61508:2010 (see page 8 (with HS model) and page 10 (without HS model)).
- SIL 2 for ND Load according IEC 61508:2010 (see pages 9 (with HS model) and pages 11 (without HS model)).
- Systematic capability SIL 3.
- 2 universal AC Input Lines, nominal 110 to 240 Vac ($\pm 10\%$) (48 to 62 Hz).
- Power factor correction.
- Hot swappable modules.
- EMC Compatibility to EN61000-6-2, EN61000-6-4.
- TÜV Functional Safety Certification.
- Highly regulated output of 48 Vdc - 50 A, due to 24 Vdc out for each PSM1250 module.
- Under and over voltage alarm monitoring, for each PSM1250 module.
- 3 over voltage redundant protections, for each PSM1250 module.
- For each group, redundant parallel connection of PSM1250 modules with load sharing.
- Reduces Power dissipation (in parallel/redundant configuration of each group) by replacing a Schottky diode with Mosfet Active Ideal Diode.
- 89% efficiency @230 Vac input and 48 Vdc output and full load.
- PSM1250 fan speed control depending on ambient temperature and output power.
- High load fuse breaking capability without interrupting operations.
- 19" Rack unit, 4U high, anodized aluminium, durable metal enclosure.
- Tropicalization for electronic components.
- Modbus RTU RS-485 diagnostic output.

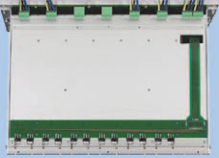
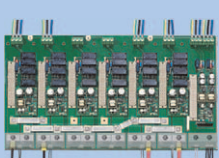

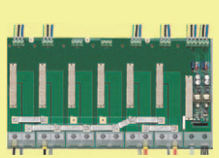
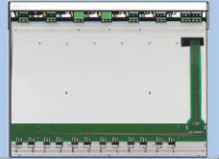
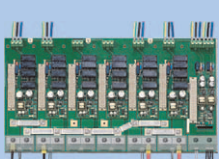
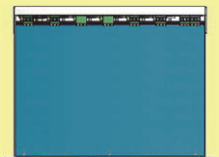
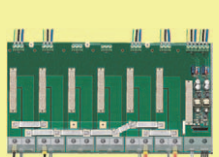
Ordering Information

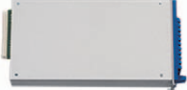
Rack unit & Back panel	Back Panel PCB	Configuration	Hot Swapping	Ordering code of PSS1250	NOT included rack slot items
 wall mounting into a cabinet		19 inches wide rack 1 output 48 Vdc up to 50 A with redundance	YES	PSS1250-HS-7-48-D-W	PSM1250 : needed 4 pieces plugged into 4 slots (1st & 2nd + 5th & 6th) PSO1250 : 1 piece (optional) plugged into 7th slot MCHP228 : needed 2 pieces plugged into 3rd & 4th slots + 1 piece plugged into 7th slot if PSO1250 is not required
 wall mounting into a cabinet		1 diagnostic module (optional)	NO	PSS1250-7-48-D-W	
 frontal rack mounting into a cabinet		19 inches wide rack 1 output 48 Vdc up to 50 A with redundance	YES	PSS1250-HS-7-48-D-F	PSM1250 : needed 4 pieces plugged into 4 slots (1st & 2nd + 5th & 6th) PSO1250 : 1 piece (optional) plugged into 7th slot MCHP228 : needed 2 pieces plugged into 3rd & 4th slots + 1 piece plugged into 7th slot if PSO1250 is not required
 frontal rack mounting into a cabinet		1 diagnostic module (optional)	NO	PSS1250-7-48-D-F	

Photos	Ordering code of rack slot items
	Needed 4 pieces of PSM1250 power supply module with 24 Vdc – 50 A output
	1 piece of PSO1250 (optional) diagnostic module with touch screen LCD color display
	Needed 2 pieces of MCHP228 blank panel to fill not used 3rd and 4th rack slots + 1 piece of MCHP228 to fill 7th slot if PSO1250 is not required

Hot swapping capability

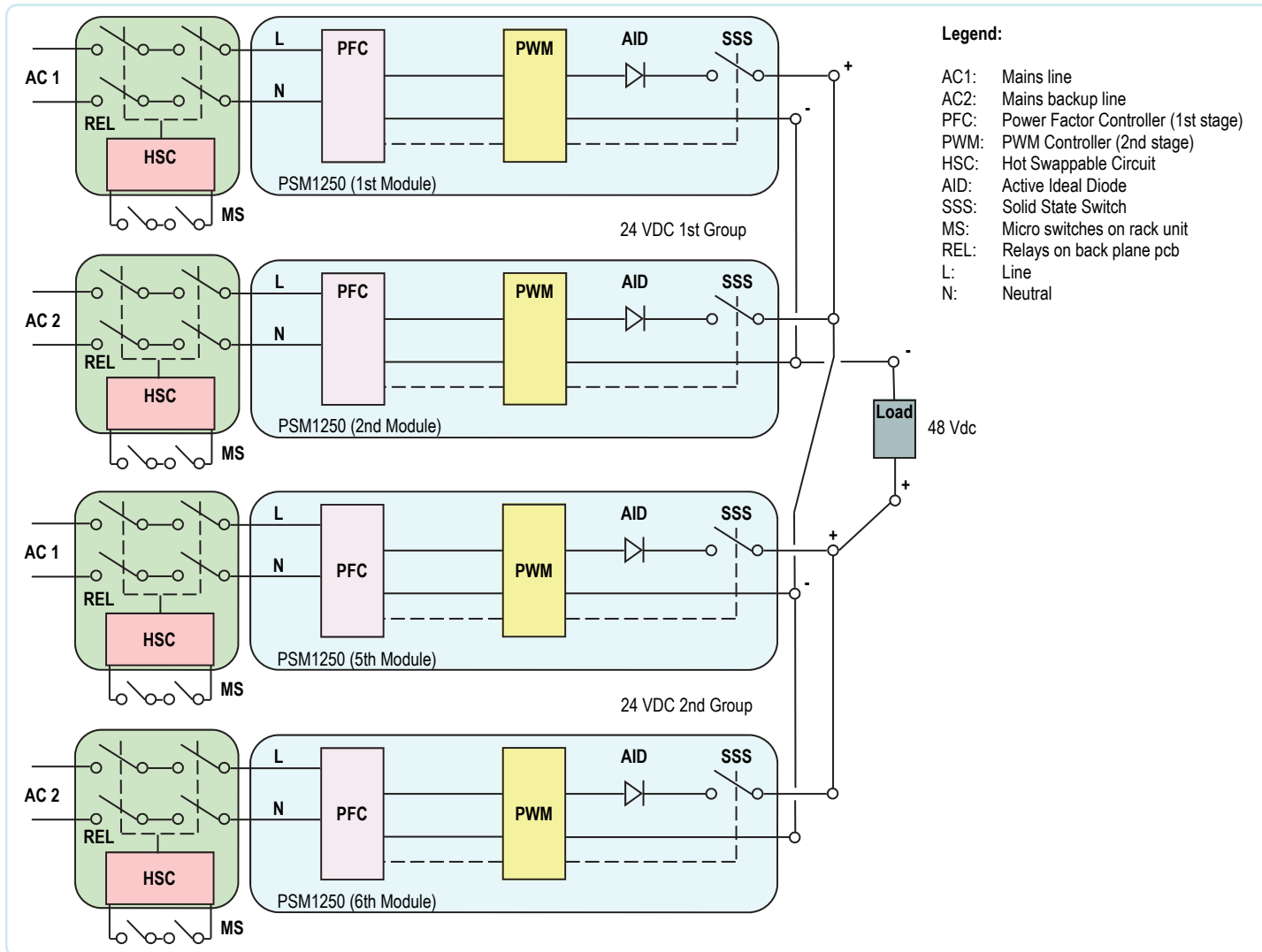

PSS1250-HS-7-48-D Power Supply System with Hot Swapping (HS) capability is able to provide power and it is fully protected from the Hot Swapping of any power, or diagnostic, module. This protection system operates for both the insertion and disconnection of the modules.

When inserting the module, the mains voltage is only applied when mechanical and electrical module connections are completely and correctly positioned, while before disconnecting the module the external electrical connections have to be at zero voltage level.

To achieve this result, a sophisticated 1002 mechanical and electrical protection circuit, using micro switches (MS), relays (REL) and special hot swapping circuits (HSC), has been designed. All power modules have a mains terminal block for Line-Neutral-Earth/Ground, placed in the back panel pcb that can be used for two independent mains lines (AC1 & AC2). The Line and Neutral are connected to the power module via two couples of 1002 series contact relays, driven from hot swapping circuit according to closed or open state of 1002 series mechanical switches. Two micro switches for each power module are placed in the front part of the 19" Rack unit and are activated (closed) by front panel top screws used to fix the module at rack. For each power module, 4 relays are installed on the back panel pcb, close to the mains terminal blocks, in 1002 architecture for safety purposes.

For further safety, close to the relays, for each position, there is a red LED. Before inserting a power module, the operator must verify that related red LED is OFF.

If the red LED is turned ON, a failure is present on a couple of series relays or HS controller circuit could be damaged and no power module shall be inserted and fixed in that position.

The opening of the micro switches, operated by unscrewing at least one of two front panel top screws, initiates the following two actions:

1. Mains line is disconnected from the power module, because hot swapping circuit de-energizes relays, opening their contacts;
2. Voltage on the power module connectors is brought to 0 volts, to avoid any sparking possibility. This is done by a MOSFET solid state switch (SSS) connected in series with the *active ideal diodes (AID)*, which disconnects the output from the DC output bus. The internal voltage in the disconnected power module remains completely isolated from the output connections and therefore, even if an operator shorts the connections with a screw driver or any other tool, this will not generate a spark.

When a power module is inserted and fixed to rack unit by its screws, the MOSFET solid state switch remains open until the power supply starts to operate correctly, then it closes itself applying voltage to the load.

Reasons for using an Ideal Diode-OR Controller circuit, in N+1 redundant power supply applications with high availability systems

High availability systems often employ power supply modules connected in parallel to achieve redundancy and enhance system reliability.

ORing diodes have been a popular means of connecting these supplies at a point of load. The disadvantage of this approach is the forward voltage drop and resulting efficiency loss. This drop reduces the available supply voltage and dissipates significant power.

Replacing Schottky diodes with N-channel MOSFETs reduces power dissipation and eliminates the need for expensive heat sinks or large thermal layouts in high power applications. In the Ideal Diode-OR Controller circuit (*active ideal diode*), the voltage across source and drain is monitored by IN and OUT pins, and GATE pin drives the MOSFETs to control their operation. In effect the MOSFET source and drain serve as the anode and cathode of an ideal diode.

In the event of a power supply failure, for example if the output of a fully loaded supply is suddenly shorted to ground, reverse current temporarily flows through the MOSFETs that are ON. This current is sourced from any load capacitance and from the other supplies. The active ideal diode quickly responds to this condition turning off the MOSFETs in about 0.5µs, thus minimizing disturbance and oscillations to the output bus.

Using Oring diodes to parallel two 24 Vdc power supply modules of each group for redundancy, one Schottky diode is used for each module. The voltage drop across the diode can reach about 0.8 V at 50 A, this means about 40 W dissipation for each module. For each group, if two 50 A paralleled modules are used for full 50 + 50 A redundancy, a total power of about 80 W is dissipated for this purpose, but there are two groups of PSM1250 modules, so that total dissipation will be **160 W**. This reduces efficiency, reliability and increases space for heat sinks. Moreover, in case of module failure, diodes take time to recover and consequently they do not preserve the load from transients during the backup operation.

To avoid all these problems G.M. International has introduced, in the new PSS1250 Power Supply System, the use of *active ideal diodes*.

The MOSFETs resistance for *active ideal diodes* is about 1.2 mΩ resulting in 3.6 W dissipation for each power module. For each group, if two 50 A paralleled modules are used for full 50 + 50 A redundancy, a total power of about **2 x 7.2 W = 14.4 W** is dissipated for the purpose resulting in about **ten times less** dissipation compared to Schottky diodes solution. This increases efficiency, reliability, availability and reduces space for heat sinks.

This circuit provides also very smooth voltage switchovers without oscillations with fast turnoff, minimizing reverse current transients.

Output voltage setting - Fault indications - Diagnostic information

For each PSM1250 power module, the output voltage can be set to 24 Vdc + 18%; -14% via a front panel trimmer (see page 18 (for system with HS) or page 22 (for system without HS) for more information about voltage adjust procedure). Therefore, for whole PSS1250(-HS)-7-48-D system, the output voltage can be set to 2 x 24 Vdc = 48Vdc + 18%; -14%.

For each PSM1250 power module, under voltage threshold is set to 19.5 V, while Over voltage threshold is set to 29.5 V.

A front panel power ON green LED signals mains voltage is applied to the power module and normal DC output voltage is present on DC output screw terminals.

Power module Fault conditions are signaled by opening contact of NE relay (contact closed in normal condition), positioned on back panel pcb "Fault" terminal block.

Faults can be:

- Under voltage Vout < 19.5 V.
- Over voltage Vout > 29.5 V.

In absence of under / over voltage fault, the green Power ON LED is ON if output voltage is within 19.5 V - 29.5 V range.

If output voltage goes below 19.5 V, the green Power ON LED blinks and holds this condition as long as output voltage goes over 20 V.

If output voltage goes over 29.5 V, the green Power ON LED is OFF and holds this condition as long as output voltage goes below 29 V.

After under / over voltage fault, coming back to normal condition, the green Power ON LED is ON if output voltage is within 20 V - 29 V range.

Communication with four power modules is achieved via PSO1250 diagnostic module, which incorporates a front panel color touch screen. The diagnostic module is able to query each power modules (using an internal proprietary bus) and read data such as, Input/Output Voltage, Current and Power; Input Line Frequency; Output current sharing percentage related to each group; Internal Temperature; alarm status (under/over out voltage, AC line absence, internal PFC or PWM stage in OFF state, internal high temperature, fans malfunctioning).

This information is available via front panel touch LCD and externally via Modbus RTU on related wall mounting terminal block. Alarm status of one or more power modules is signalled by opening contact of NE relay (contact closed in normal condition), positioned on back panel pcb "Comm. Fault" terminal block. The diagnostic module **does not interfere** with the Power system functional safety. The power system can perfectly work without the diagnostic module and any failure of the diagnostic module does not affect system performance, reliability and SIL level of Functional Safety applications.

About PSS1250(-HS)-7-48-D fault indication, it's important to connect in series the Fault relay contacts of: the 1st and the 5th PSM1250 modules (which define the 1st 48V generator); the 2nd and the 6th PSM1250 modules (which define the 2nd 48V generator). When a PSM1250 module goes in fault condition which reflect a fault condition on related 48V generator. Both series connections (one for each 48V generator) of Fault relay contacts should be connected to Safety PLC inputs to read status of these contacts and detect possible faults.

For more information about how to connect Fault relay contacts, please see next Functional Safety applications on pages 8 to 11.

Warning

 PSS1250(-HS)-7-48-D is isolated Switching Power Supply unit located in Safe Area or Nonhazardous Locations within the specified operating temperature limits $-40^{\circ}\text{C} \leq T_{\text{amb}} \leq +70^{\circ}\text{C}$ and mounting conditions. Read installation manual before operating the unit. PSS1250(-HS)-7-48-D must be installed, wired, operated and maintained only by qualified personnel, in accordance to the relevant national/international installation standards, following established installation rules.

Green Power ON LED of PSM1250 power module: check that green LED is OFF before screwing out PSM1250 module front panel. **Red LED (one for each PSM1250 slot position, only for system with HS capability) on wall mounting panel board:** connect a PSM1250 power module to the rack unit only if corresponding red LED on back panel board is in OFF state. This equipment is an open-type device and is meant to be installed in an enclosure suitable for the environment such that the equipment is only accessible with the use of a tool.

The enclosure provides, according to EN60529, an IP20 minimum degree of protection (or similar to NEMA Standard 250 type 1). The equipment shall only be used in an area of at least pollution degree 2, as defined in IEC 60664-1. The end user is responsible to ensure that the operating temperature of the module is not exceeded in the end use application.

Units must be protected against dirt, dust, extreme mechanical (e.g. vibration, impact and shock) and thermal stress, and casual contacts.

All circuits connected to PSS1250(-HS)-7-48-D must comply with the overvoltage category II (or better) according to EN/IEC60664-1.

Electrostatic Hazard: the enclosure of PSS1250 series must be cleaned only with a damp or antistatic cloth.

Any penetration of cleaning liquid must be avoided to prevent damage to the unit. Failure to properly installation or use of the equipment may risk to damage the unit or severe personal injury. The unit cannot be repaired by the end user and must be returned to the manufacturer or his authorized representative. Any unauthorized modification must be avoided.

Storage

If after an incoming inspection the unit is not installed directly on a system (parts for spare or expansion with long storage periods) it must be conveniently stocked.

Stocking area characteristics must comply with the following parameters. Temperature -40 to $+70$ °C, the -45 to $+80$ °C is meant for limited periods, -10 to $+30$ °C is preferred.

Humidity 0 to 95 %, 0 to 60 % humidity is preferred. **Vibration:** no prolonged vibration should be perceivable in the stocking area to avoid loosening of parts or fatigue ruptures of components terminals. **Pollution:** presence of pollutant or corrosive gases or vapors must be avoided to prevent corrosion of conductors and degradation of insulating surfaces.

Disposal

The product should not be disposed with other wastes at the end of its working life. It may content hazardous substances for the health and the environment, to prevent possible harm from uncontrolled waste disposal, please separate this equipment from other types of wastes and recycle it responsibly to promote the sustainable reuse of material resources.

This product should not be mixed with other commercial wastes for disposal.

Function Diagram Dual AC Supply wiring architecture for PSS1250-HS-7-48-D or PSS1250-7-48-D:

SAFE AREA,
NON HAZARDOUS LOCATIONS

PSS1250-HS-7-48-D or PSS1250-7-48-D, dual AC supply, 1 redundant 48 Vdc - 50 A Output, PSO1250 overview module

Series of two groups, each with two paralleled PSM1250 modules, to provide full redundancy on AC lines (AC1 and AC2) and one 48 Vdc - 50 A redundant output.

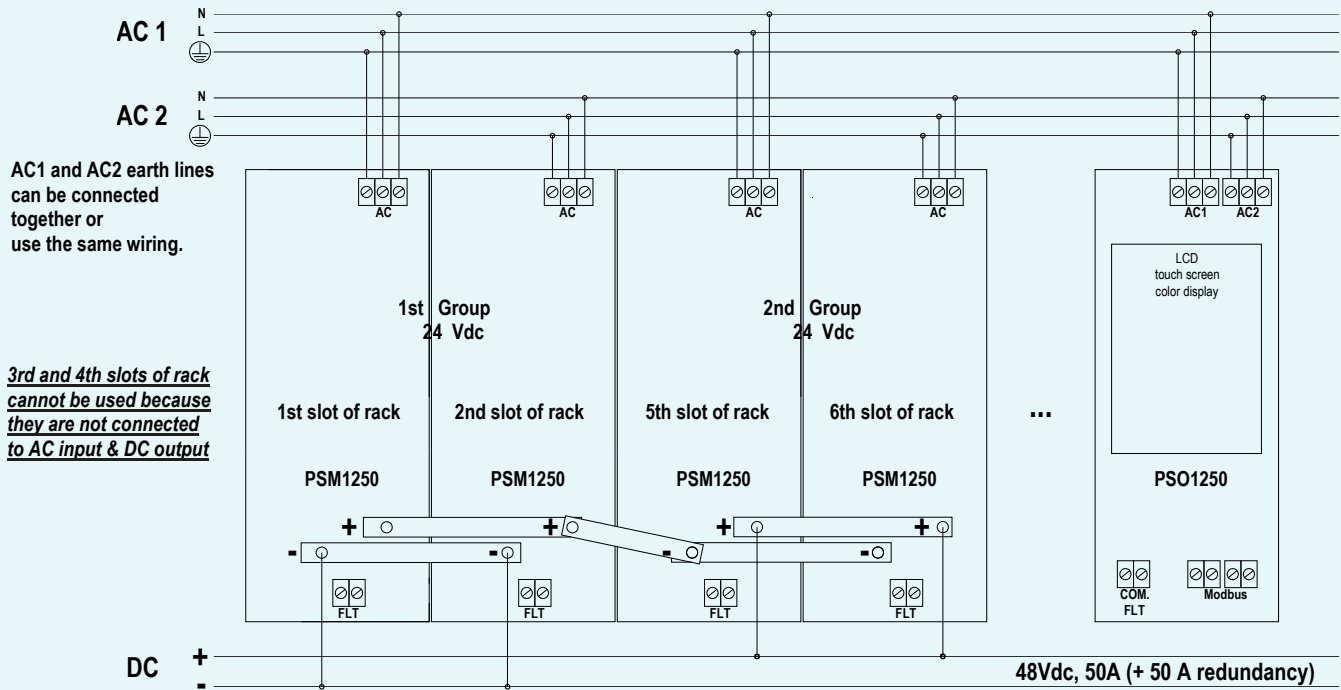

Back Panel PCB of PSS1250-HS-7-48-D with Hot Swapping circuits:

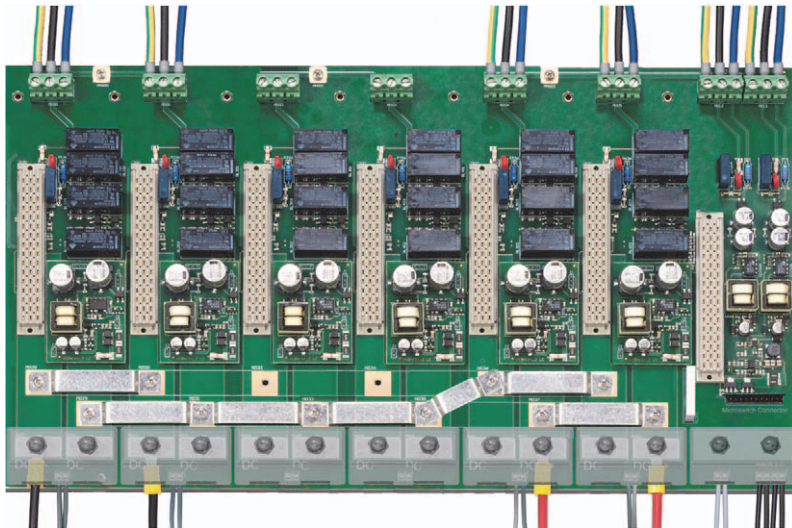

Back Panel PCB of PSS1250-7-48-D without Hot Swapping circuits:

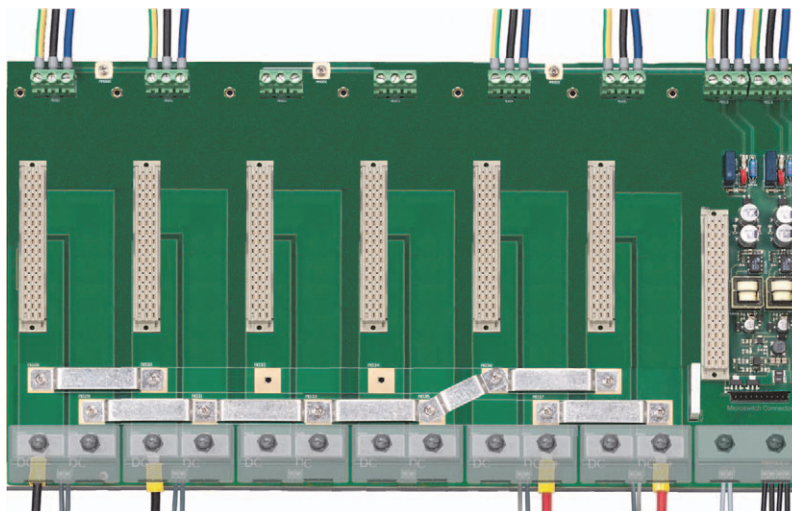

1) Application with HS capability and NE output load

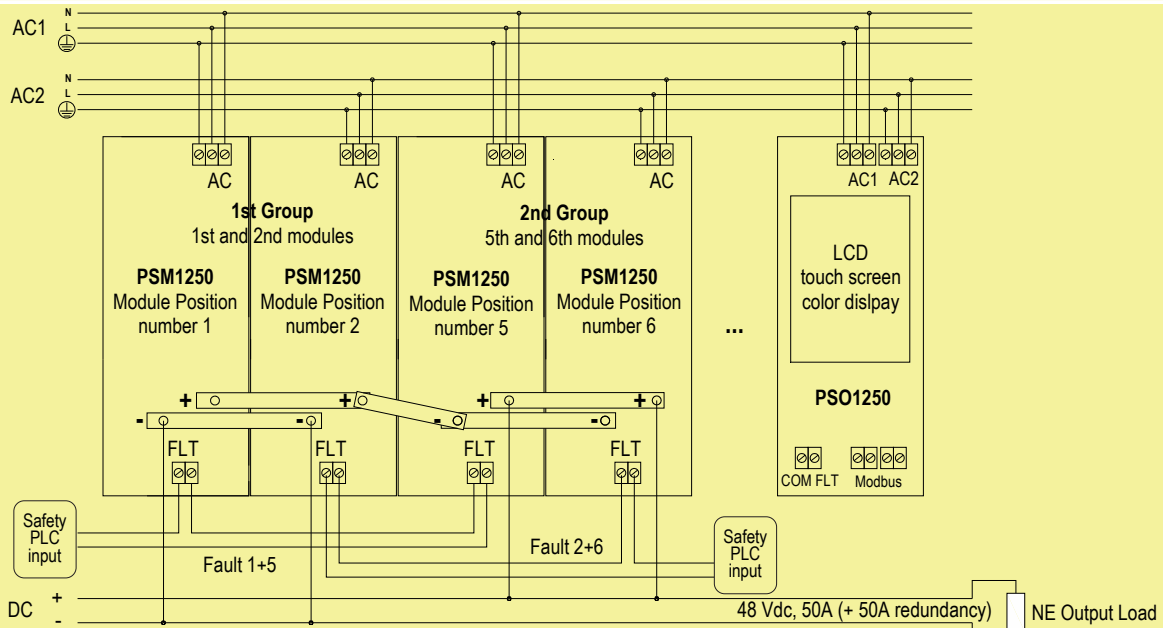

Description: In normal operation 2+2 PSM1250 modules are powered by connecting AC1 input supply to two modules and AC2 input supply to other ones by means of related terminal blocks on the Back Panel PCB (see previous functional diagram for more information). The 1st and 5th PSM1250 fault relay contacts must be connected in series to Safety PLC or Safety logic solver. The 2nd and 6th PSM1250 fault relay contacts must be connected in series to Safety PLC or Safety logic solver. Each power supply internal diagnostic uses this contact to notifies under/over voltage module faults to logic solver, which can require to turn off this power supply and to replace it with a new PSM1250 module. In absence of module fault the relay contact is closed, while in presence of module fault the relay contact is open. Green Power ON LED of each PSM1250 is lit with AC input presence. The outputs of the 1st and 2nd PSM1250 modules are already paralleled on the Back Panel PCB by specific copper bars, in order to give the 1st Group output. The outputs of the 5th and 6th PSM1250 modules are already paralleled on the Back Panel PCB by specific copper bars, in order to give the 2nd Group output. The positive (+) pole of the 1st Group output is already connected (by specific copper bar on the Back Panel PCB) to the negative (-) pole of the 2nd Group output, in order to connect in series two groups and to get 48 Vdc output. Therefore, the NE output load is connected (by related output copper bars with screw terminals on the Back Panel PCB) between the negative (-) pole of the 1st Group output and the positive (+) pole of the 2nd Group output, that is 48 Vdc power system output. In normal condition, NE output load is Normally Energized (NE). In absence of one only AC input supply (AC1 or AC2), two PSM1250 modules are shutdown (their fault relay contacts are open) but the other ones operate in normal condition, so that output load is normally energized. In absence of both AC input supplies (AC1 and AC2), 2+2 PSM1250 modules are shutdown (their fault relay contacts are open) and output load is de-energized (Safe State).

Safety Function and Failure behavior: PSS1250 with HS and 2+2 PSM1250 modules is considered to be operating in Low Demand mode, as a Type A module, having Hardware Fault Tolerance (HFT) = 1 or redundant configuration 1+1 on input/output. Its failure behaviour for NE output load is described by the following definitions:

- Fail-Safe State: it is defined as the system output going below 4 Vdc. Internal diagnostics detect and notify Low/High (Under/Over voltage) fails (DD) to logic solver, which can operate to convert these fails to the fail-safe state, requiring to turn off all malfunctioning power supplies and to replace them with new PSM1250 modules.
- Fail Safe: failure mode that causes the system to go to the defined fail-safe state without a demand from the process.
- Fail Dangerous: failure mode that does not respond to a demand from the process (i.e. being unable to go to the defined fail-safe state), so that the system output voltage is blocked or oscillating between 4 and 40 Vdc or above 60 Vdc, and both internal diagnostics cannot detect and notify faults to logic solver.
- Fail High - Overvoltage: failure mode that causes the system output to go above 60 Vdc. Internal overvoltage protections try to limit system output voltage < 60 Vdc, otherwise internal crowbars trip to fail safe state for system output ≥ 60 Vdc. Internal diagnostics detect and notify High fail to logic solver, which does not automatically trip on this failure, classified as Dangerous Detected (DD).
- Fail Low - Undervoltage: failure mode that causes the system output to go between 4 and 40 Vdc. Internal diagnostics detect and notify Low fail to logic solver, which does not automatically trip on this failure, classified as Dangerous Detected (DD).
- Fail "No Effect": failure mode of a component that plays a part in implementing the safety function but that is neither a safe failure nor a dangerous failure, so that the system output voltage is deviated between 40 and 60 Vdc. When calculating the SFF, this failure mode is not taken into account.
- Fail "Not part": failure mode of a component that is not part of the safety function but part of the circuit diagram and is listed for completeness. When calculating the SFF, this failure mode is not taken into account.

The PSO1250 diagnostic module **does not interfere** with power system functional safety. The power system can perfectly work without diagnostic module and any failure of the PSO1250 diagnostic module does not affect system performance, reliability and SIL level of this Functional Safety application. Failure rate data are from Siemens Standard SN29500.

Failure rate table:

Failure category	Failure rates (FIT)
λ_{dd} = Total Dangerous Detected failures	11.72
λ_{du} = Total Dangerous Undetected failures	5.66
λ_{sd} = Total Safe Detected failures	0.00
λ_{su} = Total Safe Undetected failures	189.08
$\lambda_{tot\ safe}$ = Total Failure Rate (Safety Function) = $\lambda_{dd} + \lambda_{du} + \lambda_{sd} + \lambda_{su}$	206.46
MTBF (safety function) = $(1 / \lambda_{tot\ safe}) + MTTR$ (8 hours)	553 years
$\lambda_{no\ effect}$ = "No Effect" failures	12165.06
$\lambda_{not\ part}$ = "Not Part" failures	1068.36
$\lambda_{tot\ device}$ = Total Failure Rate (Device) = $\lambda_{tot\ safe} + \lambda_{no\ effect} + \lambda_{not\ part}$	13439.88
MTBF (device) = $(1 / \lambda_{tot\ device}) + MTTR$ (8 hours)	8.5 years
PFDavg (TI = 1 year) = $\lambda_{du} * (0.5 * 8760 + 8)h + \lambda_{dd} * 8h$	2.493E-05

Failure rates table according to IEC 61508:2010 :

λ_{sd}	λ_{su}	λ_{dd}	λ_{du}	SFF	DC _D
0.00 FIT	189.08 FIT	11.72 FIT	5.66 FIT	97.26%	67.43%

PFDavg vs T[Proof] table, with determination of SIL supposing module contributes 10% of entire safety function:

T[Proof] = 4 years	T[Proof] = 20 years
PFDavg = 9.97E-05 Valid for SIL 3	PFDavg = 4.99E-04 Valid for SIL 2

PFDavg vs T[Proof] table, with determination of SIL supposing module contributes 20% of entire safety function:

T[Proof] = 8 years	T[Proof] = 20 years
PFDavg = 1.99E-04 Valid for SIL 3	PFDavg = 4.99E-04 Valid for SIL 2

Systematic capability SIL 3.

2) Application with HS capability and ND output load

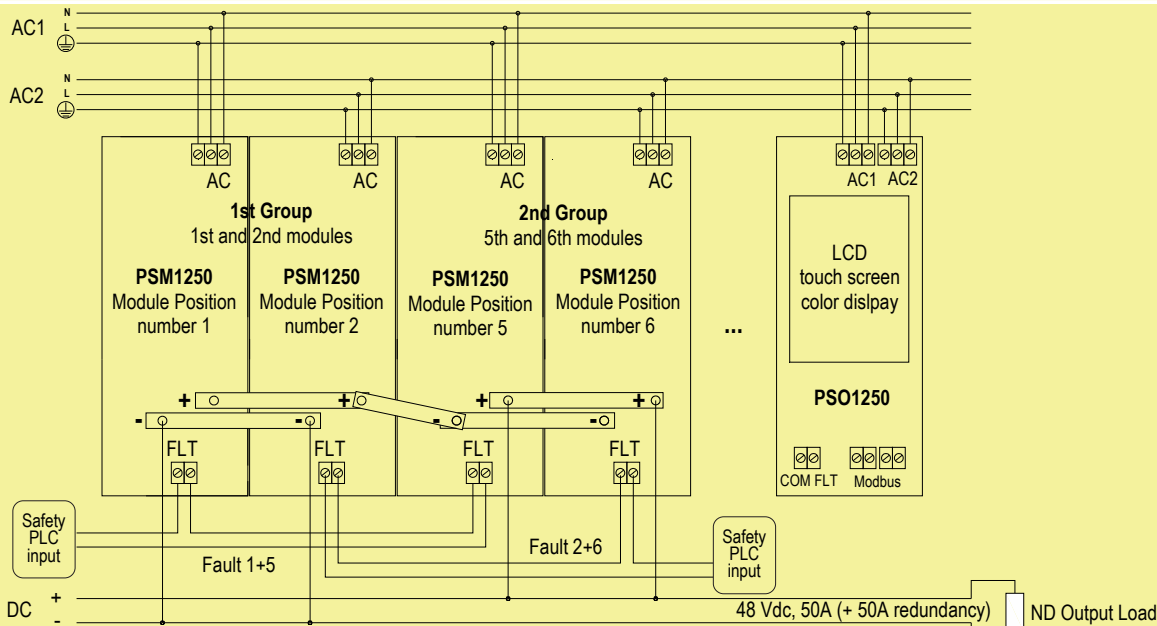

Description: In normal operation 2+2 PSM1250 modules are powered by connecting AC1 input supply to two modules and AC2 input supply to other ones by means of related terminal blocks on the Back Panel PCB (see previous functional diagram for more information). The 1st and 5th PSM1250 fault relay contacts must be connected in series to Safety PLC or Safety logic solver. The 2nd and 6th PSM1250 fault relay contacts must be connected in series to Safety PLC or Safety logic solver. Each power supply internal diagnostic uses this contact to notifies under/over voltage module faults to logic solver, which can require to turn off this power supply and to replace it with a new PSM1250 module. In absence of module fault the relay contact is closed, while in presence of module fault the relay contact is open. Green Power ON LED of each PSM1250 is lit with AC input presence. The outputs of the 1st and 2nd PSM1250 modules are already paralleled on the Back Panel PCB by specific copper bars, in order to give the 1st Group output. The outputs of the 5th and 6th PSM1250 modules are already paralleled on the Back Panel PCB by specific copper bars, in order to give the 2nd Group output. The positive (+) pole of the 1st Group output is already connected (by specific copper bar on the Back Panel PCB) to the negative (-) pole of the 2nd Group output, in order to connect in series two groups and to get 48 Vdc output. Therefore, the ND output load is connected (by related output copper bars with screw terminals on the Back Panel PCB) between the negative (-) pole of the 1st Group output and the positive (+) pole of the 2nd Group output, that is 48 Vdc power system output. In normal condition, absence of both AC input supplies (AC1 and AC2) implies that 2+2 PSM1250 modules are shutdown (their fault relay contacts are open) and output load is Normally De-energized (ND). In presence of one only AC input supply (AC1 or AC2), two PSM1250 modules are shutdown (their fault relay contacts are open) but the other ones are correctly turned on, so that output load is energized (Safe State). In presence of both AC input supplies (AC1 and AC2), 2+2 PSM1250 modules are correctly turned on and output load is energized (Safe State).

Safety Function and Failure behavior: PSS1250 with HS and 2+2 PSM1250 modules is considered to be operating in Low Demand mode, as a Type A module, having Hardware Fault Tolerance (HFT) = 1 or redundant configuration 1+1 on input/output. Its failure behaviour for ND output load is described by the following definitions:

- Fail-Safe State: it is defined as the system output going between 40 and 60 Vdc. Internal diagnostics detect and notify High (Over voltage) fails (DD) to logic solver, which can operate to convert these fails to the fail-safe state, requiring to turn off malfunctioning power supply and to replace it with new PSM1250 module.
- Fail Safe: failure mode that causes the system to go to the defined fail-safe state without a demand from the process.
- Fail Dangerous: failure mode that does not respond to a demand from the process (i.e. being unable to go to the defined fail-safe state), so that the system output voltage is blocked or oscillating between 0 and 40 Vdc or above 60 Vdc, and internal diagnostic cannot detect and notify faults to logic solver.
- Fail High - Overvoltage: failure mode that causes the system output to go above 60 Vdc. Internal overvoltage protection tries to limit output voltage < 60 Vdc, otherwise for output ≥ 60 Vdc internal crowbars trip, turning off malfunctioning power supply. Internal diagnostics detect and notify High fail to logic solver, which does not automatically trip on this failure, classified as Dangerous Detected (DD).
- Fail Low - Undervoltage: failure mode that causes the system output to go between 0 and 40 Vdc. This failure mode is dangerous, but internal diagnostic notifies Low fail to logic solver, which cannot convert this failure to the fail-safe state but it can only require to turn off malfunctioning power supply and to replace it with a new PSM1250 module.
- Fail "Not part": failure mode of a component that is not part of the safety function but part of the circuit diagram and is listed for completeness. When calculating the SFF, this failure mode is not taken into account.

The PS01250 diagnostic module **does not interfere** with power system functional safety. The power system can perfectly work without diagnostic module and any failure of the PS01250 diagnostic module does not affect system performance, reliability and SIL level of this Functional Safety application. Failure rate data are from Siemens Standard SN29500.

Failure rate table:

Failure category	Failure rates (FIT)
λ_{dd} = Total Dangerous Detected failures	7.64
λ_{du} = Total Dangerous Undetected failures	198.82
λ_{sd} = Total Safe Detected failures	0.00
λ_{su} = Total Safe Undetected failures	12165.06
$\lambda_{tot\ safe}$ = Total Failure Rate (Safety Function) = $\lambda_{dd} + \lambda_{du} + \lambda_{sd} + \lambda_{su}$	12371.52
MTBF (safety function) = $(1 / \lambda_{tot\ safe}) + MTTR$ (8 hours)	9 years
$\lambda_{not\ part}$ = "Not Part" failures	1068.36
$\lambda_{tot\ device}$ = Total Failure Rate (Device) = $\lambda_{tot\ safe} + \lambda_{no\ effect} + \lambda_{not\ part}$	13439.88
MTBF (device) = $(1 / \lambda_{tot\ device}) + MTTR$ (8 hours)	8.5 years
PFDAvg (TI = 1 year) = $\lambda_{du} * (0.5 * 8760 + 8)h + \lambda_{dd} * 8h$	8.72E-04

Failure rates table according to IEC 61508:2010 :

λ_{sd}	λ_{su}	λ_{dd}	λ_{du}	SFF	DC _D
0.00 FIT	12165.06 FIT	7.64 FIT	198.82 FIT	98.39%	3.70%

PFDAvg vs T[Proof] table, with determination of SIL supposing module contributes 10% of entire safety function:

T[Proof] = 1 years	T[Proof] = 11 years
PFDAvg = 8.72E-04 Valid for SIL 2	PFDAvg = 9.60E-03 Valid for SIL 1

PFDAvg vs T[Proof] table, with determination of SIL supposing module contributes 20% of entire safety function:

T[Proof] = 2 years	T[Proof] = 20 years
PFDAvg = 1.74E-03 Valid for SIL 2	PFDAvg = 1.74E-02 Valid for SIL 1

Systematic capability SIL 3.

3) Application without HS capability and NE output load

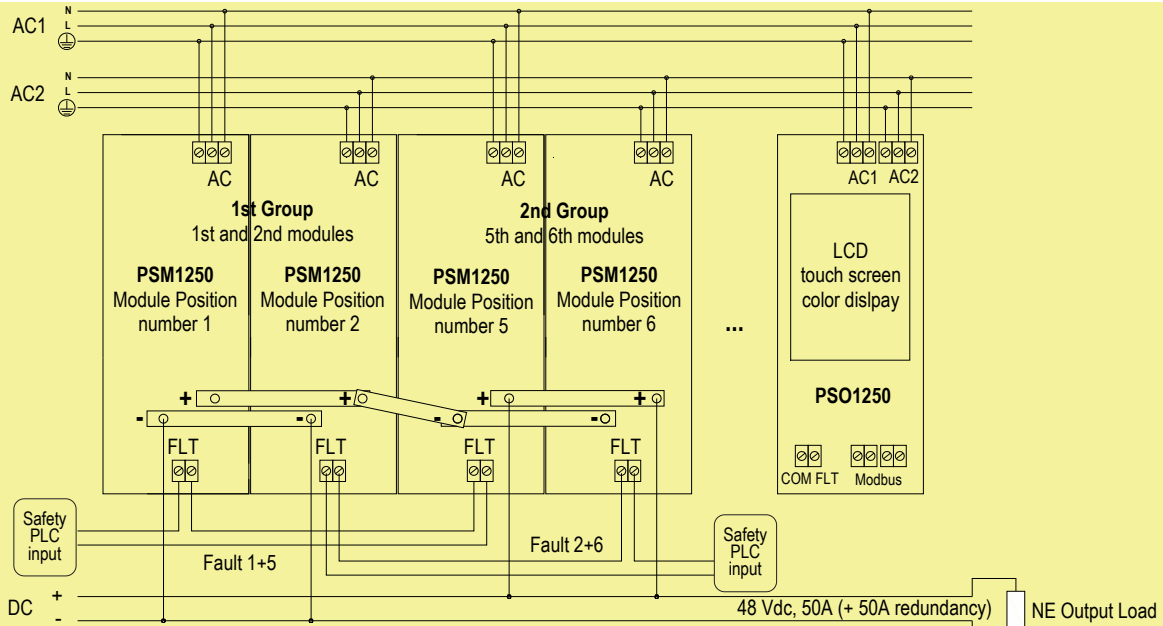

Description: In normal operation 2+2 PSM1250 modules are powered by connecting AC1 input supply to two modules and AC2 input supply to other ones by means of related terminal blocks on the Back Panel PCB (see previous functional diagram for more information). The 1st and 5th PSM1250 fault relay contacts must be connected in series to Safety PLC or Safety logic solver. The 2nd and 6th PSM1250 fault relay contacts must be connected in series to Safety PLC or Safety logic solver. Each power supply internal diagnostic uses this contact to notifies under/over voltage module faults to logic solver, which can require to turn off this power supply and to replace it with a new PSM1250 module. In absence of module fault the relay contact is closed, while in presence of module fault the relay contact is open. Green Power ON LED of each PSM1250 is lit with AC input presence. The outputs of the 1st and 2nd PSM1250 modules are already paralleled on the Back Panel PCB by specific copper bars, in order to give the 1st Group output. The outputs of the 5th and 6th PSM1250 modules are already paralleled on the Back Panel PCB by specific copper bars, in order to give the 2nd Group output. The positive (+) pole of the 1st Group output is already connected (by specific copper bar on the Back Panel PCB) to the negative (-) pole of the 2nd Group output, in order to connect in series two groups and to get 48 Vdc output. Therefore, the NE output load is connected (by related output copper bars with screw terminals on the Back Panel PCB) between the negative (-) pole of the 1st Group output and the positive (+) pole of the 2nd Group output, that is 48 Vdc power system output. In normal condition, NE output load is Normally Energized (NE). In absence of one only AC input supply (AC1 or AC2), two PSM1250 modules are shutdown (their fault relay contacts are open) but the other ones operate in normal condition, so that output load is normally energized. In absence of both AC input supplies (AC1 and AC2), 2+2 PSM1250 modules are shutdown (their fault relay contacts are open) and output load is de-energized (Safe State).

Safety Function and Failure behavior: PSS1250 without HS and 2+2 PSM1250 modules is considered to be operating in Low Demand mode, as a Type A module, having Hardware Fault Tolerance (HFT) = 1 or redundant configuration 1+1 on input/output. Its failure behaviour for NE output load is described by the following definitions:

- Fail-Safe State: it is defined as the system output going below 4 Vdc. Internal diagnostics detect and notify Low/High (Under/Over voltage) fails (DD) to logic solver, which can operate to convert these fails to the fail-safe state, requiring to turn off all malfunctioning power supplies and to replace them with new PSM1250 modules.
- Fail Safe: failure mode that causes the system to go to the defined fail-safe state without a demand from the process.
- Fail Dangerous: failure mode that does not respond to a demand from the process (i.e. being unable to go to the defined fail-safe state), so that the system output voltage is blocked or oscillating between 4 and 40 Vdc or above 60 Vdc, and both internal diagnostics cannot detect and notify faults to logic solver.
- Fail High - Overvoltage: failure mode that causes the system output to go above 60 Vdc. Internal overvoltage protections try to limit system output voltage < 60 Vdc, otherwise internal crowbars trip to fail safe state for system output ≥ 60 Vdc. Internal diagnostics detect and notify High fail to logic solver, which does not automatically trip on this failure, classified as Dangerous Detected (DD).
- Fail Low - Undervoltage: failure mode that causes the system output to go between 4 and 40 Vdc. Internal diagnostics detect and notify Low fail to logic solver, which does not automatically trip on this failure, classified as Dangerous Detected (DD).
- Fail "No Effect": failure mode of a component that plays a part in implementing the safety function but that is neither a safe failure nor a dangerous failure, so that the system output voltage is deviated between 40 and 60 Vdc. When calculating the SFF, this failure mode is not taken into account.
- Fail "Not part": failure mode of a component that is not part of the safety function but part of the circuit diagram and is listed for completeness. When calculating the SFF, this failure mode is not taken into account.

The PSO1250 diagnostic module **does not interfere** with power system functional safety. The power system can perfectly work without diagnostic module and any failure of the PSO1250 diagnostic module does not affect system performance, reliability and SIL level of this Functional Safety application. Failure rate data are from Siemens Standard SN29500.

Failure rate table:

Failure category	Failure rates (FIT)
λ_{dd} = Total Dangerous Detected failures	11.70
λ_{du} = Total Dangerous Undetected failures	5.66
λ_{sd} = Total Safe Detected failures	0.00
λ_{su} = Total Safe Undetected failures	163.52
$\lambda_{tot\ safe}$ = Total Failure Rate (Safety Function) = $\lambda_{dd} + \lambda_{du} + \lambda_{sd} + \lambda_{su}$	180.88
MTBF (safety function) = $(1 / \lambda_{tot\ safe}) + MTTR$ (8 hours)	631 years
$\lambda_{no\ effect}$ = "No Effect" failures	10331.96
$\lambda_{not\ part}$ = "Not Part" failures	679.56
$\lambda_{tot\ device}$ = Total Failure Rate (Device) = $\lambda_{tot\ safe} + \lambda_{no\ effect} + \lambda_{not\ part}$	11192.40
MTBF (device) = $(1 / \lambda_{tot\ device}) + MTTR$ (8 hours)	10 years
PFDavg (TI = 1 year) = $\lambda_{du} * (0.5 * 8760 + 8)h + \lambda_{dd} * 8h$	2.493E-05

Failure rates table according to IEC 61508:2010 :

λ_{sd}	λ_{su}	λ_{dd}	λ_{du}	SFF	DC _D
0.00 FIT	163.52 FIT	11.70 FIT	5.66 FIT	96.87%	67.40%

PFDavg vs T[Proof] table, with determination of SIL supposing module contributes 10% of entire safety function:

T[Proof] = 4 years	T[Proof] = 20 years
PFDavg = 9.97E-05 Valid for SIL 3	PFDavg = 4.99E-04 Valid for SIL 2

PFDavg vs T[Proof] table, with determination of SIL supposing module contributes 20% of entire safety function:

T[Proof] = 8 years	T[Proof] = 20 years
PFDavg = 1.99E-04 Valid for SIL 3	PFDavg = 4.99E-04 Valid for SIL 2

Systematic capability SIL 3.

4) Application without HS capability and ND output load

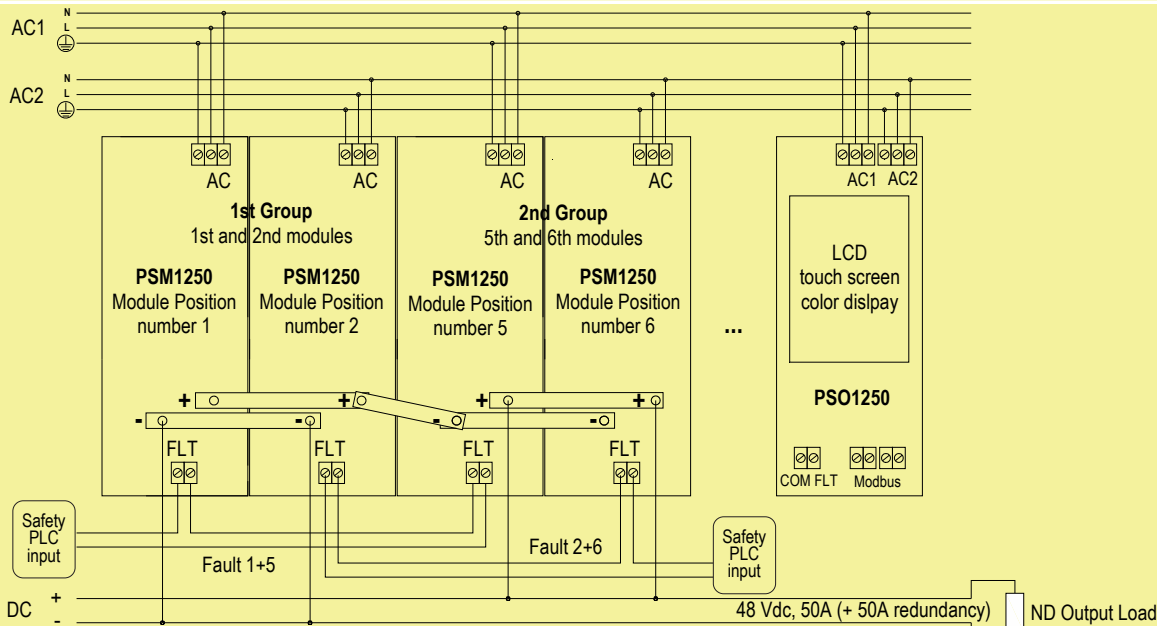

Description: In normal operation 2+2 PSM1250 modules are powered by connecting AC1 input supply to two modules and AC2 input supply to other ones by means of related terminal blocks on the Back Panel PCB (see previous functional diagram for more information). The 1st and 5th PSM1250 fault relay contacts must be connected in series to Safety PLC or Safety logic solver. The 2nd and 6th PSM1250 fault relay contacts must be connected in series to Safety PLC or Safety logic solver. Each power supply internal diagnostic uses this contact to notifies under/over voltage module faults to logic solver, which can require to turn off this power supply and to replace it with a new PSM1250 module. In absence of module fault the relay contact is closed, while in presence of module fault the relay contact is open. Green Power ON LED of each PSM1250 is lit with AC input presence. The outputs of the 1st and 2nd PSM1250 modules are already paralleled on the Back Panel PCB by specific copper bars, in order to give the 1st Group output. The outputs of the 5th and 6th PSM1250 modules are already paralleled on the Back Panel PCB by specific copper bars, in order to give the 2nd Group output. The positive (+) pole of the 1st Group output is already connected (by specific copper bar on the Back Panel PCB) to the negative (-) pole of the 2nd Group output, in order to connect in series two groups and to get 48 Vdc output. Therefore, the ND output load is connected (by related output copper bars with screw terminals on the Back Panel PCB) between the negative (-) pole of the 1st Group output and the positive (+) pole of the 2nd Group output, that is 48 Vdc power system output. In normal condition, absence of both AC input supplies (AC1 and AC2) implies that 2+2 PSM1250 modules are shutdown (their fault relay contacts are open) and output load is Normally De-energized (ND). In presence of one only AC input supply (AC1 or AC2), two PSM1250 modules are shutdown (their fault relay contacts are open) but the other ones are correctly turned on, so that output load is energized (Safe State). In presence of both AC input supplies (AC1 and AC2), 2+2 PSM1250 modules are correctly turned on and output load is energized (Safe State).

Safety Function and Failure behavior: PSS1250 without HS and 2+2 PSM1250 modules is considered to be operating in Low Demand mode, as a Type A module, having Hardware Fault Tolerance (HFT) = 1 or redundant configuration 1+1 on input/output. Its failure behaviour for ND output load is described by the following definitions:

- Fail-Safe State: it is defined as the system output going between 40 and 60 Vdc. Internal diagnostics detect and notify High (Over voltage) fails (DD) to logic solver, which can operate to convert these fails to the fail-safe state, requiring to turn off malfunctioning power supply and to replace it with new PSM1250 module.
- Fail Safe: failure mode that causes the system to go to the defined fail-safe state without a demand from the process.
- Fail Dangerous: failure mode that does not respond to a demand from the process (i.e. being unable to go to the defined fail-safe state), so that the system output voltage is blocked or oscillating between 0 and 40 Vdc or above 60 Vdc, and internal diagnostic cannot detect and notify faults to logic solver.
- Fail High - Overvoltage: failure mode that causes the system output to go above 60 Vdc. Internal overvoltage protection tries to limit output voltage < 60 Vdc, otherwise for output ≥ 60 Vdc internal crowbars trip, turning off malfunctioning power supply. Internal diagnostics detect and notify High fail to logic solver, which does not automatically trip on this failure, classified as Dangerous Detected (DD).
- Fail Low - Undervoltage: failure mode that causes the system output to go between 0 and 40 Vdc. This failure mode is dangerous, but internal diagnostic notifies Low fail to logic solver, which cannot convert this failure to the fail-safe state but it can only require to turn off malfunctioning power supply and to replace it with a new PSM1250 module.
- Fail "Not part": failure mode of a component that is not part of the safety function but part of the circuit diagram and is listed for completeness. When calculating the SFF, this failure mode is not taken into account.

The PSO1250 diagnostic module **does not interfere** with power system functional safety. The power system can perfectly work without diagnostic module and any failure of the PSO1250 diagnostic module does not affect system performance, reliability and SIL level of this Functional Safety application. Failure rate data are from Siemens Standard SN29500.

Failure rate table:

Failure category	Failure rates (FIT)
λ_{dd} = Total Dangerous Detected failures	7.64
λ_{du} = Total Dangerous Undetected failures	173.24
λ_{sd} = Total Safe Detected failures	0.00
λ_{su} = Total Safe Undetected failures	10331.96
$\lambda_{tot\ safe}$ = Total Failure Rate (Safety Function) = $\lambda_{dd} + \lambda_{du} + \lambda_{sd} + \lambda_{su}$	10512.84
MTBF (safety function) = $(1 / \lambda_{tot\ safe}) + MTTR$ (8 hours)	11 years
$\lambda_{not\ part}$ = "Not Part" failures	679.56
$\lambda_{tot\ device}$ = Total Failure Rate (Device) = $\lambda_{tot\ safe} + \lambda_{no\ effect} + \lambda_{not\ part}$	11192.40
MTBF (device) = $(1 / \lambda_{tot\ device}) + MTTR$ (8 hours)	10 years
PFDavg (TI = 1 year) = $\lambda_{du} * (0.5 * 8760 + 8)h + \lambda_{dd} * 8h$	7.60E-04

Failure rates table according to IEC 61508:2010 :

λ_{sd}	λ_{su}	λ_{dd}	λ_{du}	SFF	DC _D
0.00 FIT	10331.96 FIT	7.64 FIT	173.24 FIT	98.35%	4.22%

PFDavg vs T[Proof] table, with determination of SIL supposing module contributes 10% of entire safety function:

T[Proof] = 1 years	T[Proof] = 13 years
PFDavg = 7.60E-04 Valid for SIL 2	PFDavg = 9.88E-03 Valid for SIL 1

PFDavg vs T[Proof] table, with determination of SIL supposing module contributes 20% of entire safety function:

T[Proof] = 2 years	T[Proof] = 20 years
PFDavg = 1.52E-03 Valid for SIL 2	PFDavg = 1.52E-02 Valid for SIL 1

Systematic capability SIL 3.

Testing procedure at T-proof

According to IEC 61508-2, the proof test will be performed to reveal dangerous faults which cannot be otherwise detected. This means that it is necessary to specify how dangerous undetected faults, which have been noted during the FMEDA analysis, can be revealed during the proof test.

For **Functional Safety applications with NE output load**, the following **Proof Test** must be executed for each **PSM1250** composing the Functional Safety used application. It consists of the following steps:

Steps	Action
1	In order to control correct operating of the fault contact (FLT), necessary to give information about dangerous failures, take appropriate action on the safety-related PLC to acquire presence of fault but to not take any action because fault condition is intentionally provoked.
2	Shutdown the tested power supply module by unplugging: at least one of two top screws that fix PSM1250 into PSS1250 rack <u>with HS capability</u> ; two top and two bottom screws that fix PSM1250 into PSS1250 rack <u>without HS capability</u> and disconnecting the module from the rack unit. This action does not affect output load operating, which holds normally energized because of fully redundant configuration on input (two independent AC lines) and output (paralleling connection for each group implies high availability) of the Functional Safety application. The power supply module turn off time lasts some seconds (typically 5 to 10 sec). During this time, the power supply module output voltage goes below 19.5 Vdc (undervoltage UV condition), therefore the fault relay contact must be open and the green Power ON LED must blink. The safety-related PLC must acquire presence of fault, which proves that power supply internal diagnostic operates correctly. If the safety-related PLC does not acquire any fault, this means that fault relay contact is blocked in closed position (for welding) or power supply internal diagnostic is wrongly operating. Therefore this power supply module must be replaced with new one.
3	Turn on the tested power supply module by plugging: both two top screws that fix PSM1250 into PSS1250 rack <u>with HS capability</u> ; two top and two bottom screws that fix PSM1250 into PSS1250 rack <u>without HS capability</u> and connecting the module into the rack unit. After about 3 seconds the power supply module operates correctly in current sharing mode with other paralleled power supply module of its group. This can be seen on the TFT display of PSO1250 overview module.
4	Restore normal operation of the safety-related PLC, so that it can take any action if fault is acquired.
5	Unplug two M6 nylon-capped lock nuts, to unfix IP20 polycarbonate cover from the DC (+/-) couple screw output terminals of the tested power supply module.
6	Use an AC true rms voltmeter and connect its probes to DC (+/-) couple screw output terminals in order to measure AC rms voltage. In normal operation conditions, the output supply voltage should have no AC component, that is its rms value should be ideally null. But little ripple is allowed, therefore this value must be about 100 mVrms. If higher rms value (as some volts) is measured, a dangerous failure which has produced an oscillation of the output voltage regulator is detected. Therefore this power supply module must be replaced with new one.
7	Plug two M6 nylon-capped lock nuts, to fix IP20 polycarbonate cover on the DC (+/-) couple screw output terminals of the tested power supply module.

This test reveals 90% of all possible Dangerous Undetected failures in the PSM1250 power supply module and therefore in the PSS1250 system, when the output load is NE type.

System composition

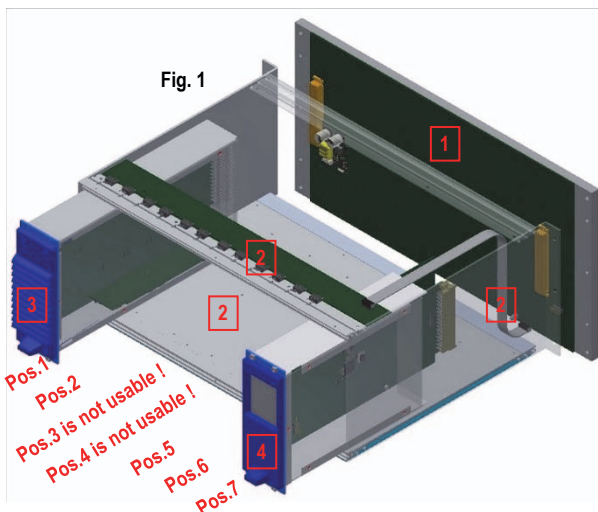

Fig. 1 shows **PSS1250-HS-7-48-D-W system** (wall mounting into a cabinet), which includes the following parts:

- 1 Back Panel and its PCB with connections for power and diagnostic modules and hot swapping control circuits;
- 2 19" Rack unit, enclosure with guides for inserting modules and microswitches board connected (by flat cable) to the hot swapping control circuits on Back Panel PCB;
- 3 4 Power Supply Modules (PSM1250), for each inserting position (Pos.1, Pos.2, Pos.5, Pos.6). The Pos.3 and Pos.4 cannot be used because they are not connected to AC input & DC output.
- 4 Diagnostic module in Pos.7 (PSO1250) with TFT LCD touch color screen for diagnostic information about each power module.

This Fig.1 can be also used for **PSS1250-HS-7-48-D-F system** (frontal rack mounting into a cabinet) because this system differs to the previous one only for the rack unit mechanical structure and not for the connections between components: 1 2 3 4. Instead, the **PSS1250-7-48-D-W or F system** (without HS capability) differs to Fig.1 system only for the absence of microswitches board, related flat cable and hot swapping control circuits on Back Panel PCB.

Installation Procedure - 1st step: Back Panel installation for PSS1250-xx-7-48-D-W (wall mounting into a cabinet)

The following drawing with overall dimensions (mm) is only applicable to types: PSS1250-HS-7-48-D-W and PSS1250-7-48-D-W.

The back panel is fixed to a vertical wall into a cabinet by means of four screws through four 7.00 mm diameter holes shown in the drawing.

The back panel must only be installed as oriented in the following drawing. On the back panel is fixed the back panel PCB by means of six screws.

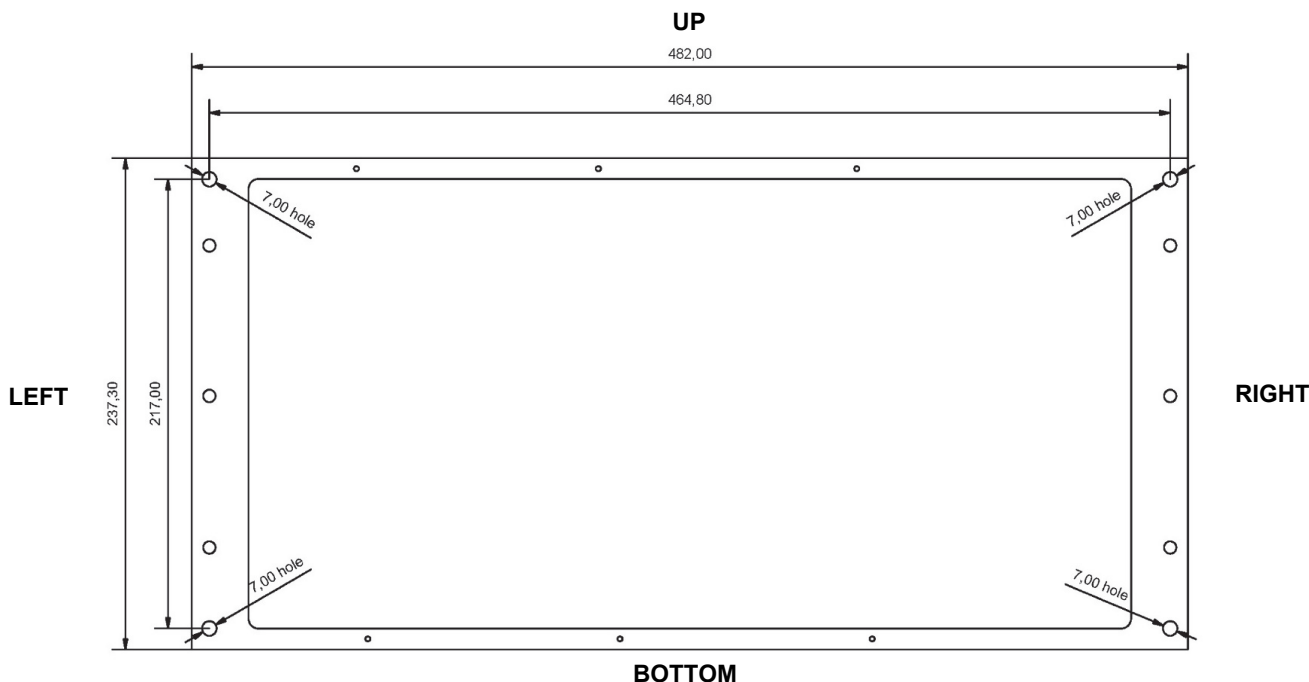

Installation Procedure - 2nd step: Wiring of AC input lines, faults and modbus terminal blocks on Back Panel PCB of PSS1250-xx-7-48-D

The following picture shows for example the terminal block wiring of PSS1250-HS-7-48-D Back Panel PCB. For PSS1250-7-48-D Back Panel PCB, the terminal block wiring is the same.

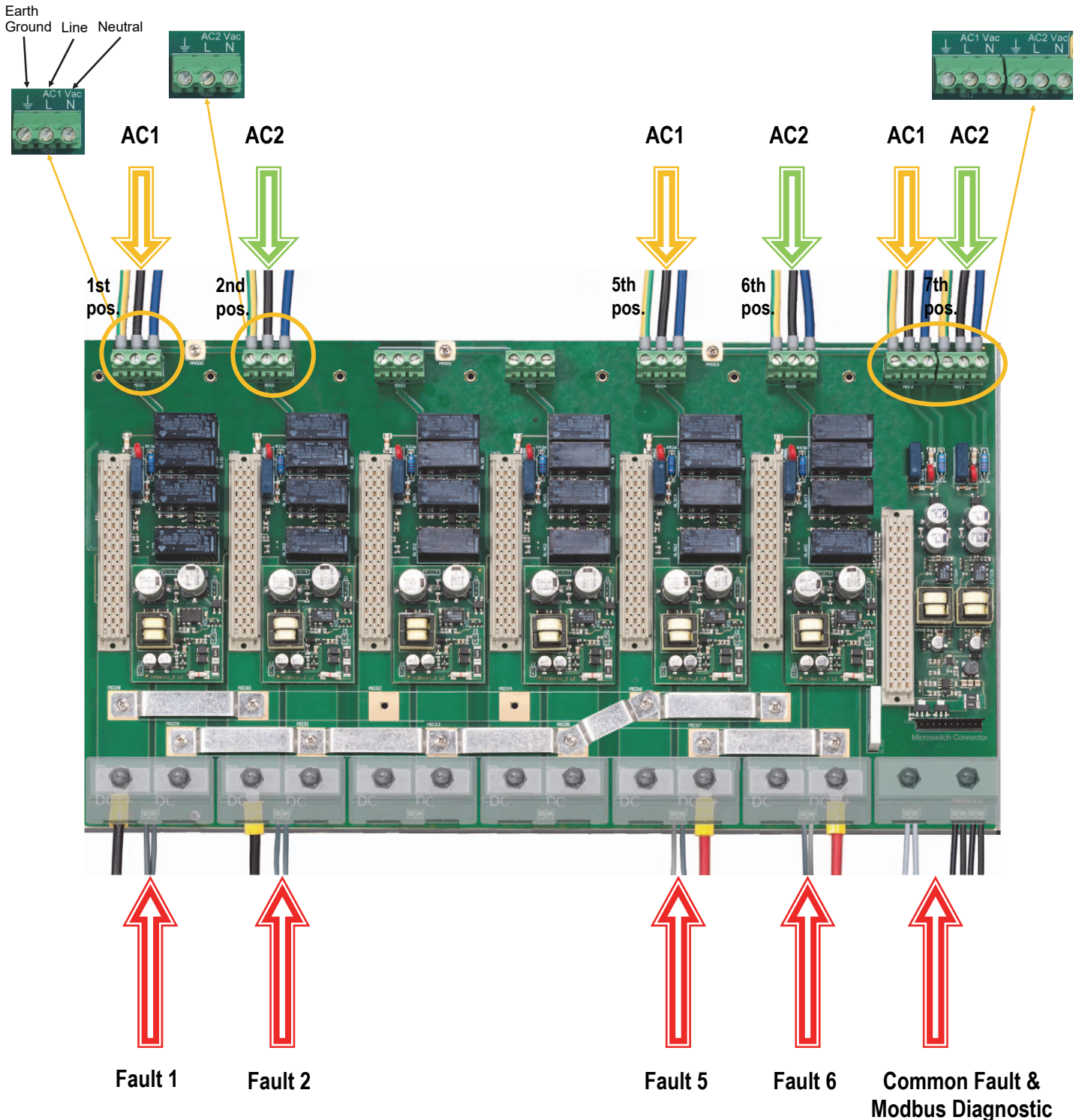

The PSS1250(-HS)-7-48-D redundant system requires to use two AC input power lines (AC1 and AC2) with different lines and neutrals but the same Earth Ground connection, in order to guarantee fully redundant configuration from the input to the output of power system.

Each PSM1250 unit slot (only 1st, 2nd, 5th and 6th, because 3rd and 4th cannot be used) must receive AC mains by means of a circuit breaker or switch with the following features:
 B or C characteristic 20 Amps when nominal low input voltage 110÷120 Vac ($\pm 10\%$) is used;
 B or C characteristic 10 Amps when nominal high input voltage 220÷240 Vac ($\pm 10\%$) is used.
 Connect AC1 input power line to input terminal blocks of positions N.1, 5 (odd positions) and connect AC2 input power line to input terminal blocks of positions N.2, 6 (even positions).
 See functional diagrams at page 7 for more information about wiring connection.

The last position on the right is used for PSO1250 diagnostic module, connect both AC1 and AC2 input power lines to related terminal blocks in order to guarantee continuous operation of diagnostic module even after shutdown of one AC input line. The PSO1250 unit slot must receive AC1 and AC2 mains by means of a circuit breaker or switch with the following features: B or C characteristic 0.5 Amps when input voltage nominal range 110÷240 Vac ($\pm 10\%$) is used.

For AC input terminal blocks, use a cable section range from 14AWG (or 2 mm²) to 11AWG (or 4 mm²) and tighten terminal block screws with maximum 0.6 Nm torque.
 For fault contact output (of each PSM1250 or common of PSO1250) and Modbus terminal blocks, use a cable section range from 20AWG (or 0.5 mm²) to 16AWG (or 1.5 mm²) and tighten terminal block screws with maximum 0.25 Nm torque. For more information about Fault connection, please see Functional Safety applications on pages 8 to 11.

AC line internal fuses are not user replaceable. The unit cannot be repaired by the end user and must be returned to the manufacturer or his authorized representative.

Installation Procedure - 3rd step: Rack unit installation on Back Plane for PSS1250-xx-7-48-D-W (wall mounting into a cabinet)

The following drawing shows overall dimensions (mm) of PSS1250-xx-7-48-D-W, with Rack unit mounted on related Back Plane with its PCB.
 Fix the Rack unit to 6 wall mounting panel bolts (3 on the right side and 3 on the left side) by means of 6 M6 nuts and groovers.

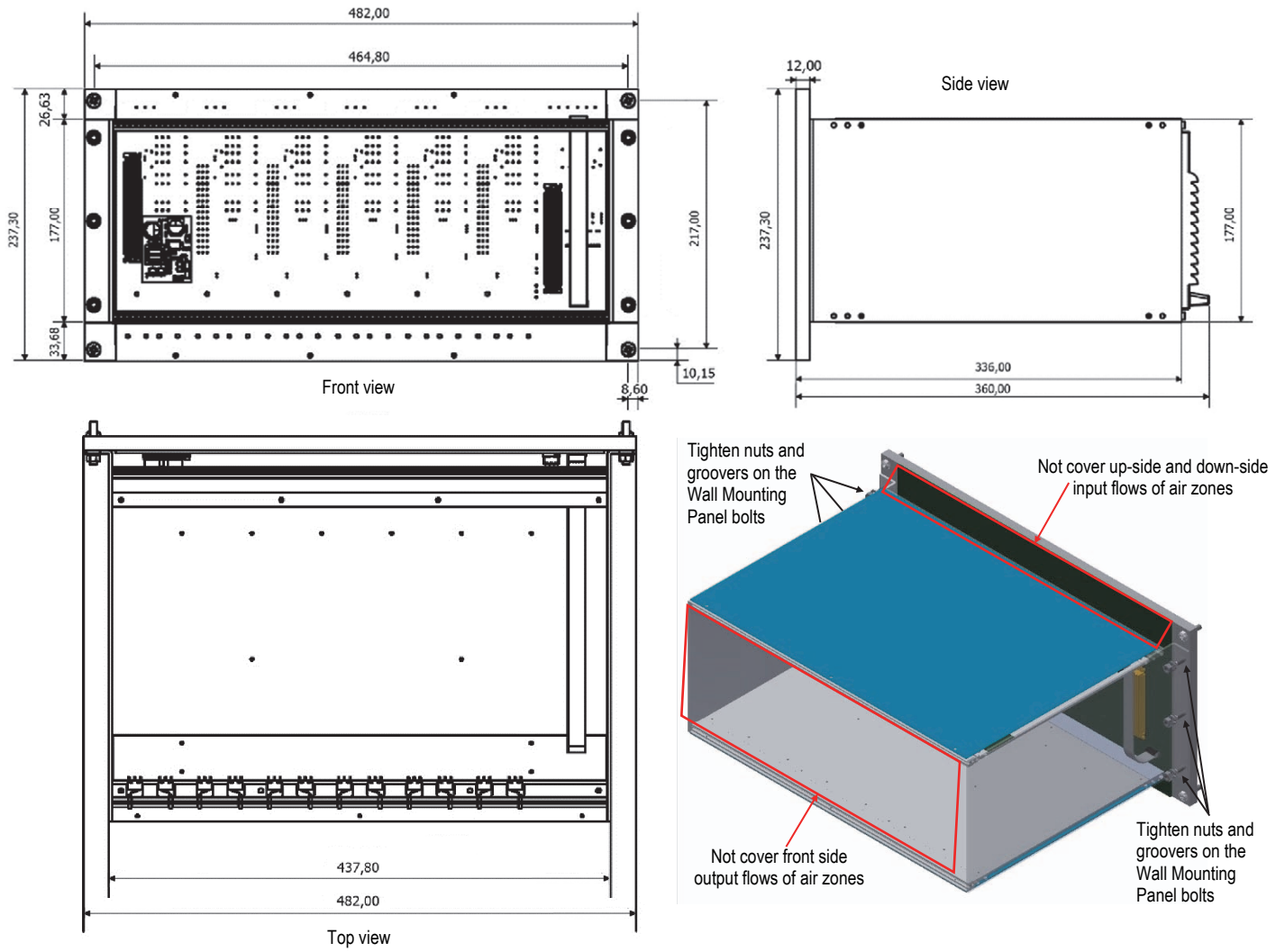

Installation Procedure - 3rd step: Installation of PSS1250-xx-7-48-D-F (frontal rack mounting into a cabinet)

The following drawing shows overall dimensions (mm) of PSS1250-xx-7-48-D-F, where Rack unit and Back Plane with its PCB are already fixed together. Fix the PSS1250 to the rack rails of a cabinet, as frontal rack mounting, matching 4 holes of Rack unit lugs (2 on the right side lug and 2 on the left side lug) with rail holes and fixing with 4 screws and related nuts. In addition, on the left and right rack sides, use a cabinet anchoring bar or bracket to hold up the rack unit.

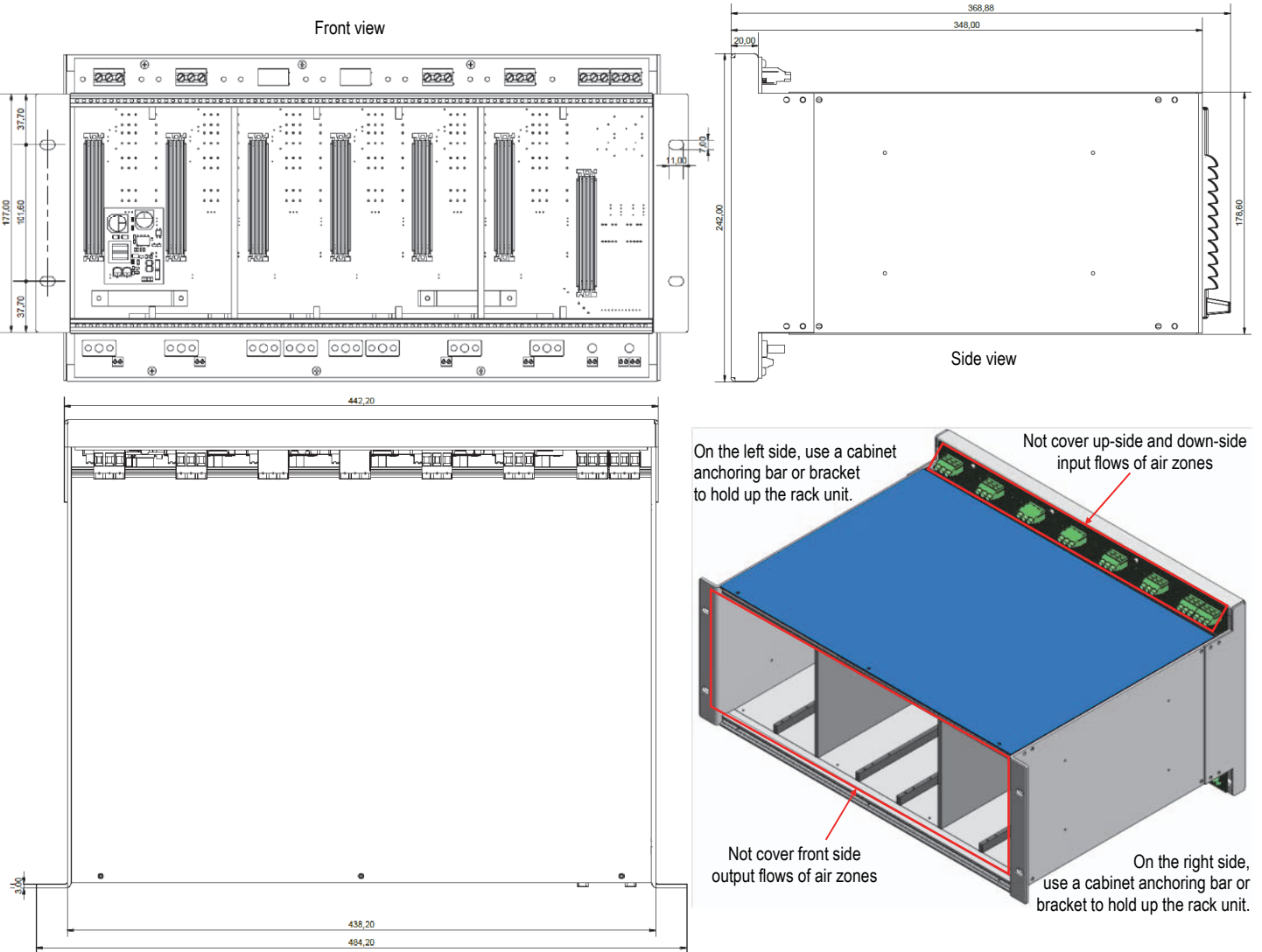

Installation Procedure - 4th step (for models with HS) - Section A: Installation of flat cable between microswitches PCB and Back Panel PCB for Hot Swapping control

Fig. 3 shows PSS1250-HS-7-48-D Back Panel PCB with a 12 poles male connector, which must be connected with the flat cable coming from the microswitches PCB of the Rack unit. In the Fig. 2-3-4-5 is shown how to connect this flat cable for PSS1250-HS-7-48-D system.

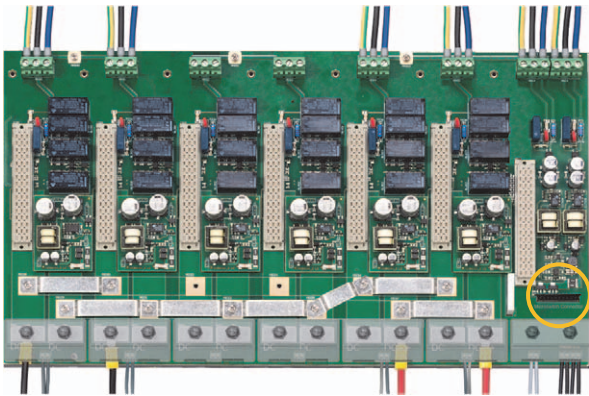

Fig. 2

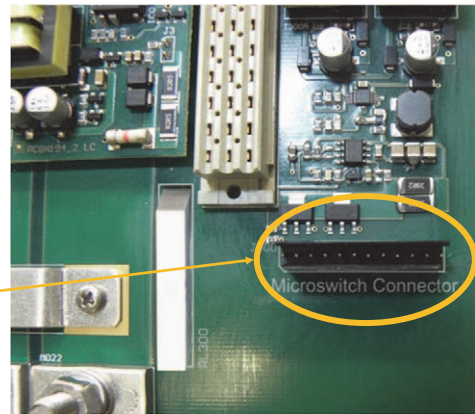

Fig. 3

During installation of the PSS1250-HS-7-48-D, connect the flat cable, coming from the microswitches PCB of the Rack unit, to the 12 poles male connector on Back Panel PCB, as shown in Fig. 4-5.

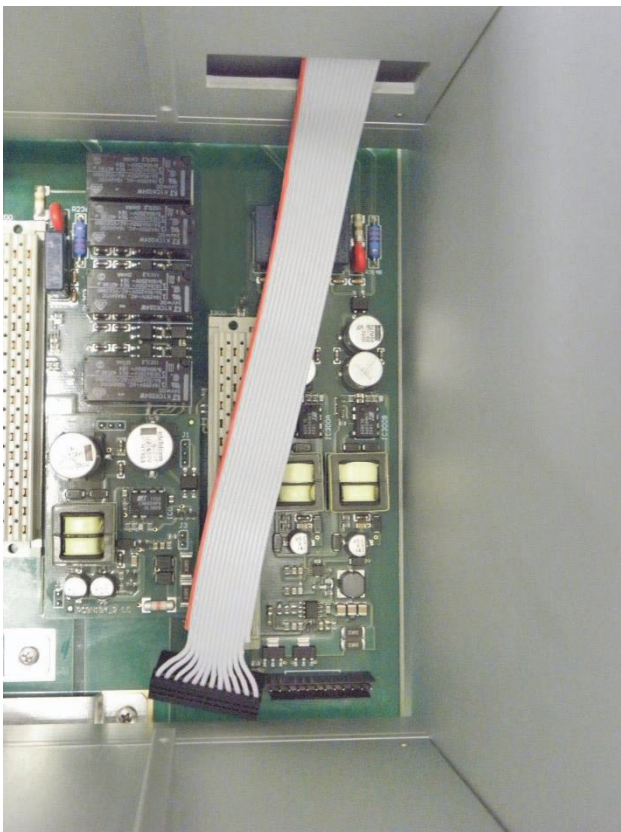

Fig. 4

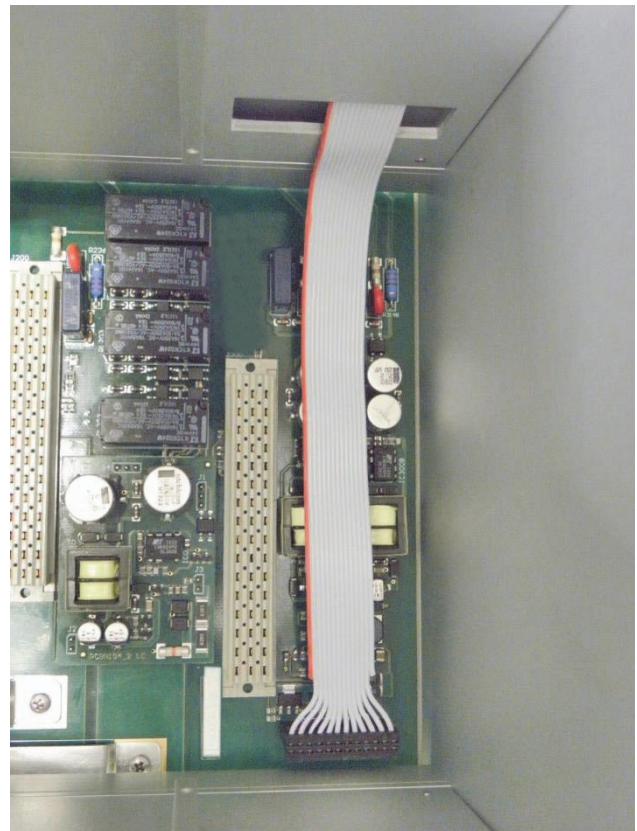
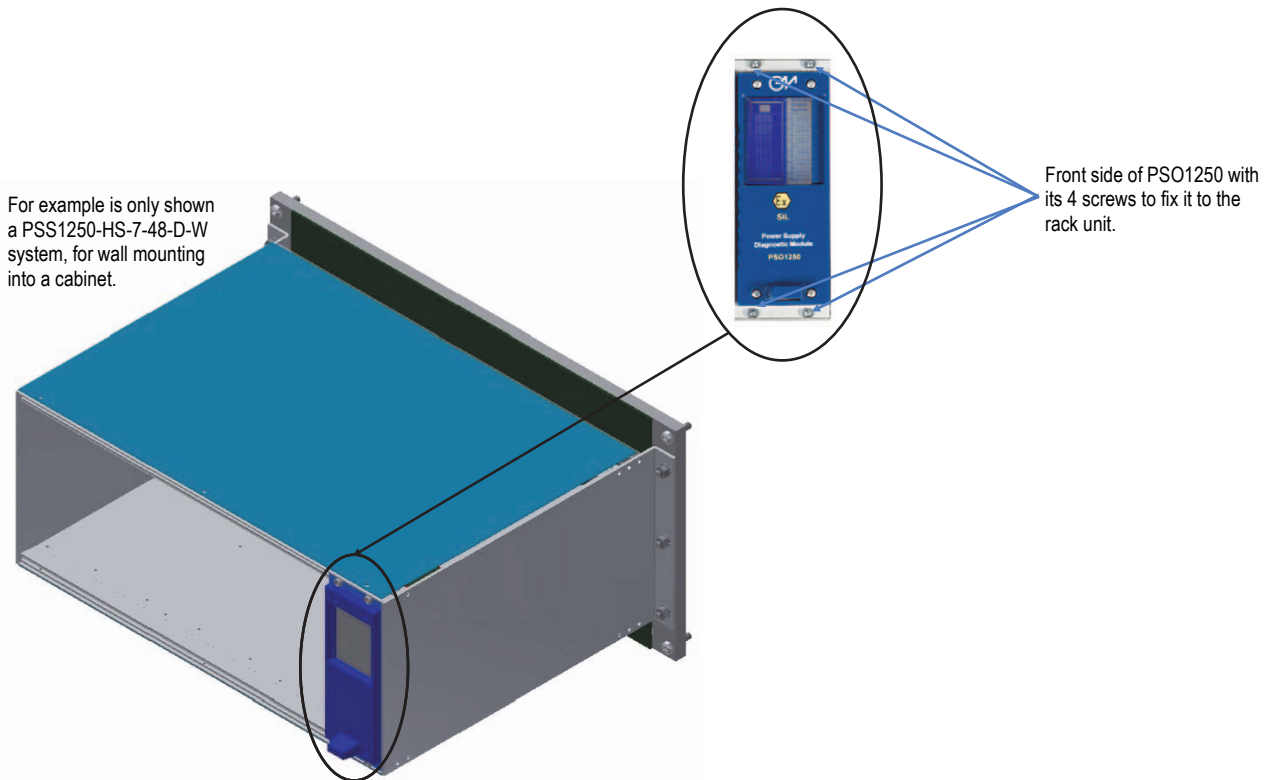

Fig. 5

Installation Procedure - 4th step (for models with HS) - Section B: Installation and start up of PSO1250 Diagnostic Module

Insert the PSO1250 diagnostic module in the last position (7th) on the right of the Rack unit and fix the module to the Rack unit by means of its 4 screws on its front side.



After installation of the PSO1250 module, **power AC1 and AC2 input power lines** in order to turn on diagnostic module. For more information about diagnostic module features and its set up, please see description from page 26.

Installation Procedure - 4th step (for models with HS) - Section C: HSC red LED signalling test

Independently from installation or not of the PSO1250 module, **power AC1 and AC2 input power lines** anyway.

Each Hot Swapping Control (HSC) circuit (one for each PSM1250 position) is supplied from AC1 or AC2 input line. The Hot Swapping Control circuit controls if PSM1250 can be installed and fixed to the Rack unit.

If no PSM1250 module is installed and fixed into the Rack unit, no Hot Swapping Control circuit can give input power lines to the Back Panel PCB female connector. In this condition, each red LED must be OFF.

If a red LED is ON, it means that related Hot Swapping Control circuit is not correctly operating and therefore no PSM1250 module shall be insert and fixed into its Rack position.

PSM1250 module can be installed and fixed into the Rack unit only if corresponding Back Panel PCB red LED is OFF.

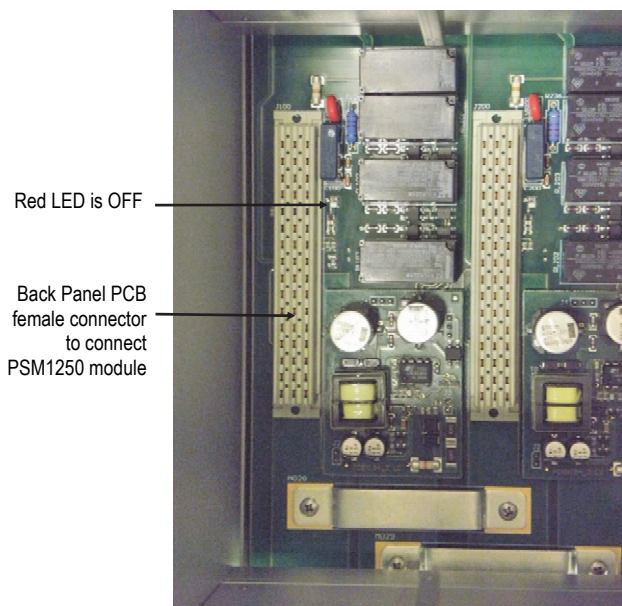

Normal condition: the red LED is OFF.
The PSM1250 module can be installed and fixed into the Rack unit position.

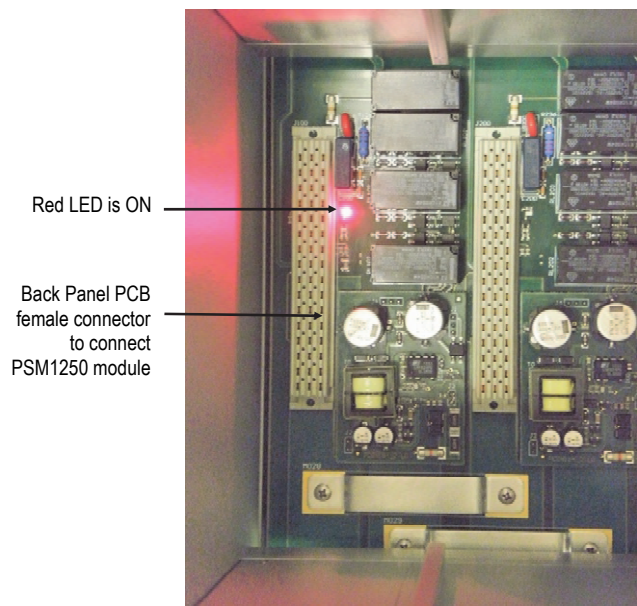

Dangerous condition: the red LED is ON.
The PSM1250 module **must not** be installed.

Installation Procedure - 4th step (for models with HS) - Section D: Installation and pre-start up of PSM1250 Power Supply Module

This step could be not executed if PSS1250-HS-7-48-D output voltage factory setting to 48 Vdc is corrected for your applications. Instead, execute this step if it's necessary to set up a different value for PSS1250-HS-7-48-D output voltage in the range 42 to 56 Vdc.

AC1 and AC2 input power lines are powered. Therefore PSM1250 module can be installed and fixed into the Rack unit only if corresponding back panel red LED is OFF.

The following procedure is split in **3 sub-steps** and it is the same for each PSM1250, independently from its position in the Rack unit.

Starting from position 1 to position 6 (excluding position 3 and 4 because cannot be used), execute pre-start up of each PSM1250 module.

1st sub-step: insert and fix the PSM1250 module into the Rack unit by means of its 4 screws on its front side. Two of them in the bottom part are only used for mechanical purpose; the other two, in the top part, when completely tightened, close the microswitches and enable the hot swap control circuit to provide input power lines to PSM1250 module by Back Panel PCB female connector. First of all, tighten 2 bottom screws and then tighten 2 top ones.

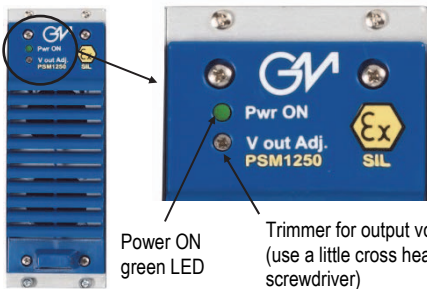
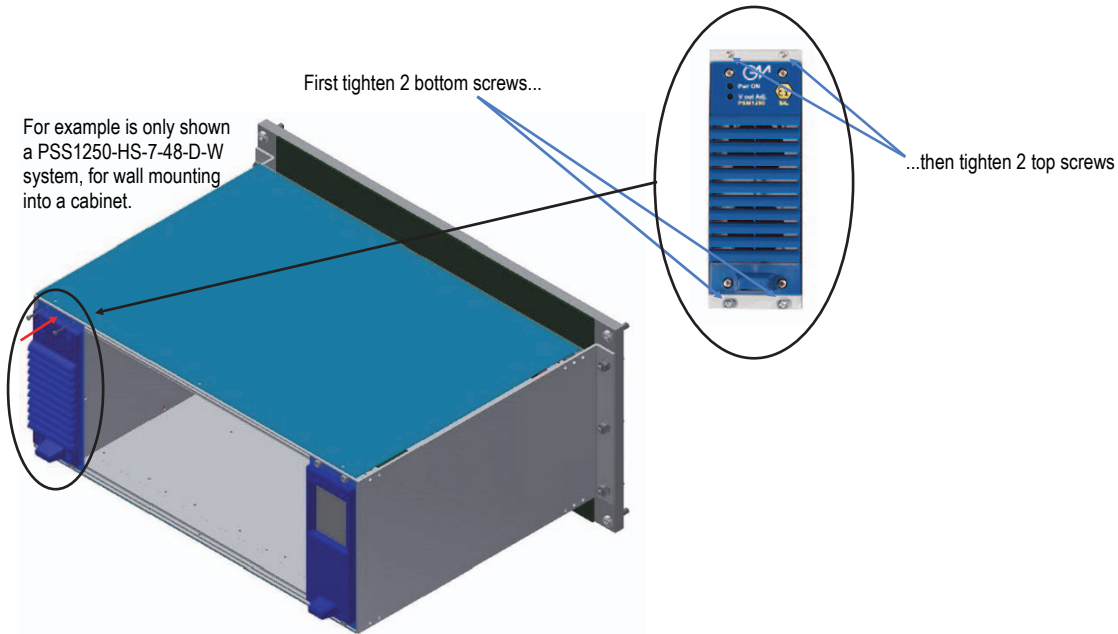

Power ON green LED

Trimmer for output voltage adjusting (use a little cross head isolated screwdriver)

2nd sub-step: with PSM1250 module powered, its front panel Power ON green LED is ON and 24 Vdc (factory setting) output voltage is present on PSM1250 screw output terminals DC- and DC+ (see page 6 for more information about Power ON green LED signalling). The output voltage can be measured on PSM1250 screw output terminals by means of a multimeter. In addition, on the TFT color screen of PSO1250 diagnostic module it is possible to monitor the PSM1250 module status and to collect information about the power supply: for example output voltage value (see description from page 26).

If it is required to set an output voltage value different from factory setting (24 Vdc), use the trimmer for output voltage adjusting. Turn the trimmer clockwise (to the right) to increase output voltage (max. 28 Vdc) or turn the trimmer counterclockwise (to the left) to decrease output voltage (min. 21 Vdc).

To set PSS1250-HS-7-48-D output voltage to $V_{out-system}$ value in the range 42 to 56 Vdc, then $V_{out-PSM}$ must be set to $V_{out-system} / 2$ value, because two groups have their outputs connected in series and each group is composed by 2 PSM1250 with paralleled outputs and with load sharing circuits. **Warning:** for correct current sharing operation in a group, power supply modules of a group must have output voltages calibrated within ± 0.5 V.



1st PSM1250 screw output terminals on copper bars:
DC1- is its negative out pole,
DC1+ is its positive out pole.

DC1- and DC2- are also negative out poles of of PSS1250-HS-7-48-D.



2nd PSM1250 screw output terminals on copper bars:
DC2- is its negative out pole,
DC2+ is its positive out pole.



5th PSM1250 screw output terminals on copper bars:
DC5- is its negative out pole,
DC5+ is its positive out pole.

DC5+ and DC6+ are also positive out poles of of PSS1250-HS-7-48-D.

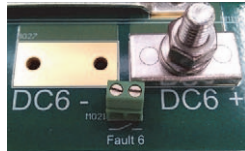

6th PSM1250 screw output terminals on copper bars:
DC6- is its negative out pole,
DC6+ is its positive out pole.

3rd sub-step: after having adjusted PSM1250 output voltage, shut down the power module unplugging the 2 top screws in order to repeat **sub-steps 1 to 3** procedure for other modules and complete the setting for all PSM1250 of PSS1250 power system.

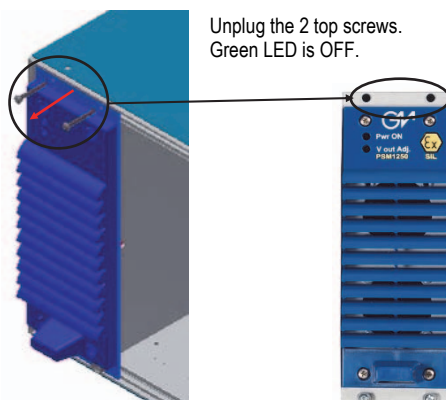

In this figure only the 1st PSM1250 module is shown but the same disconnection procedure is also applicable to other PSM1250 modules.

Installation Procedure - 4th step (for models with HS) - Section E: Wiring of 1st & 2nd PSM1250 screw output terminals on copper bars of Back Panel PCB (PSS1250-HS negative DC out lines)

At this step, PSO1250 diagnostic module is installed and fixed to rack unit with 4 screws, while each PSM1250 power module is installed and fixed to rack unit with 2 **bottom screws only** (2 top screws are unplugged to keep PSM1250 shutdown).
Unpower AC1 and AC2 input power lines (also PSO1250 will turn off) before starting the wiring of bottom screw output terminals on copper bars (DC output lines) of Back Panel PCB.

To wire negative DC output lines (DC1- and DC2- screw output terminals) of PSS1250 system, see **Fig. 6-7-8-9-10**. See functional diagrams on pages 7 for more information about wiring connection.

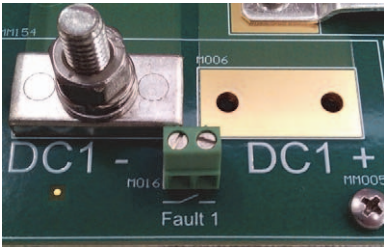

Fig. 6

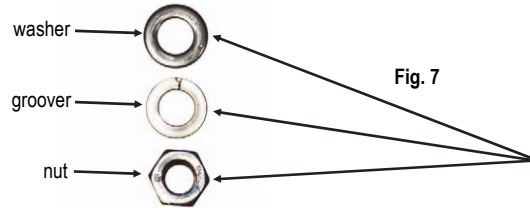
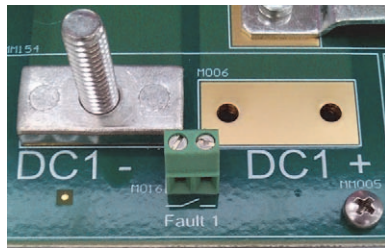
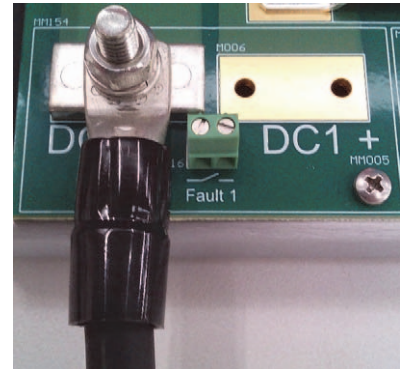
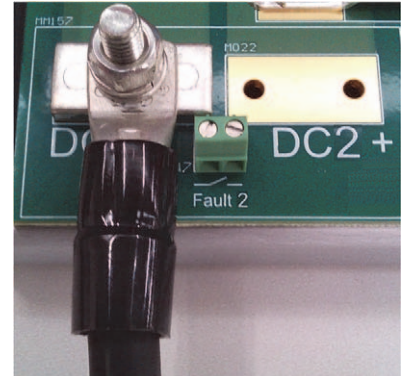
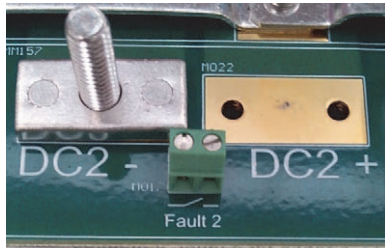

Fig. 7



Unplug M6 nut, groover and washer. Then insert the cable lug (at least 6.5 mm hole diameter) with wire (negative out wire of PSS1250 system), washer and groover on the screw output terminal. Finally tighten nut to fix wire. **Fig. 8**



For DC screw output terminals, use a cable section range from 6AWG (or 13 mm²) to 5AWG (or 16 mm²) and tighten M6 nut+groover+washer on screw with maximum 4 Nm torque.

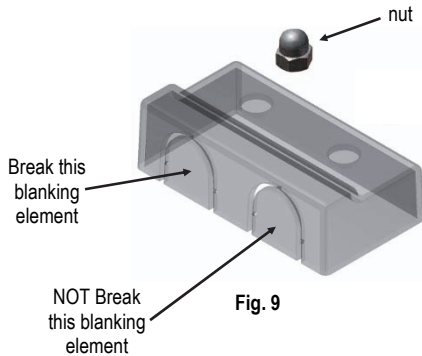

Fig. 9

A polycarbonate cover is used for IP20 to protect each couple of screw output terminals. Break only left side preformed blanking element to allow cable passage (negative out wire of PSS1250 system). Do NOT break right side preformed blanking element. Then insert and fix the cover on screw output terminal by means of M6 nylon-capped lock nut.

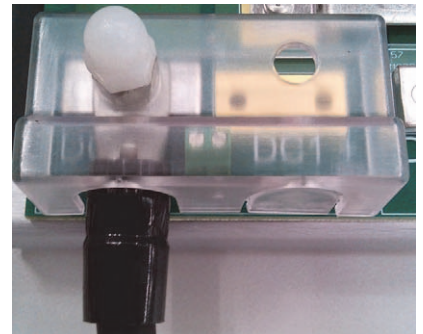
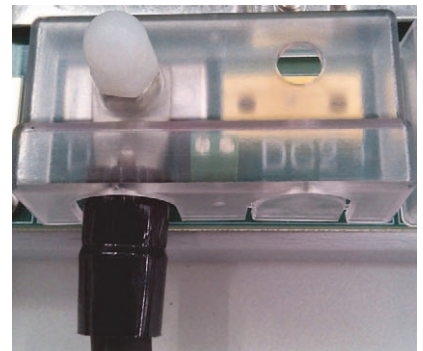

Fig. 10



Installation Procedure - 4th step (for models with HS) - Section F: Wiring of 5th & 6th PSM1250 screw output terminals on copper bars of Back Panel PCB (PSS1250-HS positive DC out lines) & PSS start-up

At this step, **AC1 and AC2 input power lines are unpowered**, PSO1250 diagnostic module is installed and fixed to rack unit with 4 screws, while each PSM1250 power module is installed and fixed to rack unit with **2 bottom screws only** (2 top screws are unplugged to keep PSM1250 shutdown).

To wire positive DC output lines (DC5+ and DC6+ screw output terminals) of PSS1250 system, see **Fig. 11-12-13-14-15**. See functional diagrams on pages 7 about wiring connection.

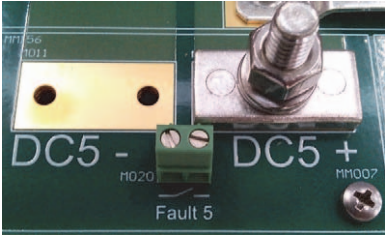
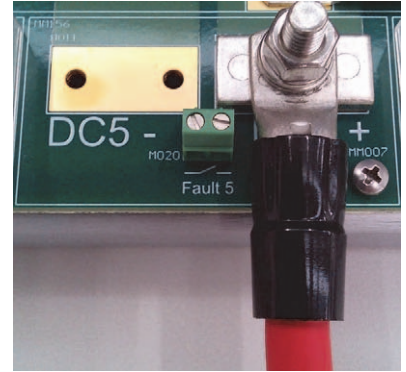
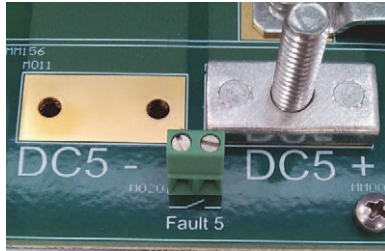

Fig. 11



Unplug M6 nut, groover and washer. Then insert the cable lug (at least 6.5 mm hole diameter) with wire (positive out wire of PSS1250 system), washer and groover on the screw output terminal. **Fig.13** Finally tighten nut to fix wire.

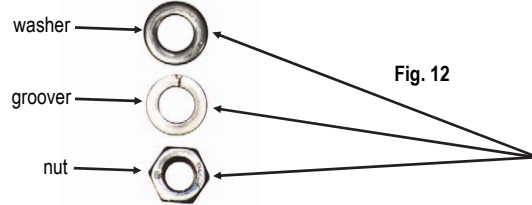
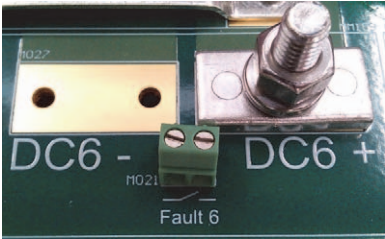
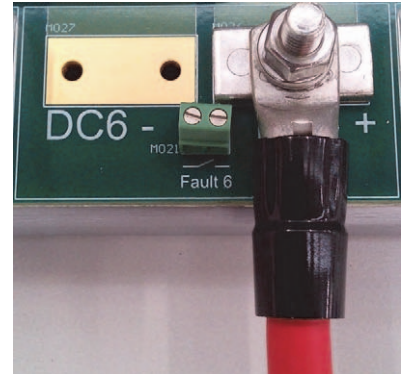
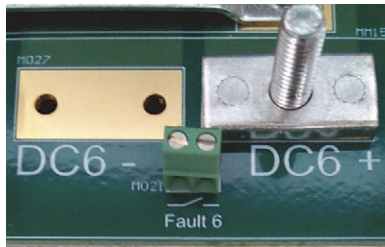

Fig. 12



For DC screw output terminals, use a cable section range from 6AWG (or 13 mm²) to 5AWG (or 16 mm²) and tighten M6 nut+groover+washer on screw with maximum 4 Nm torque.

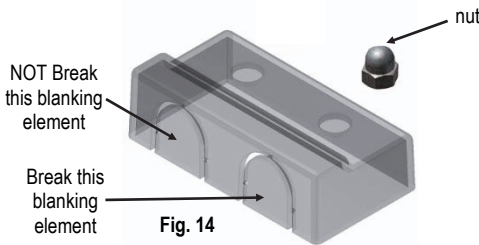

Fig. 14

A polycarbonate cover is used for IP20 to protect each couple of screw output terminals. Break only right side preformed blanking element to allow cable passage (positive out wire of PSS1250 system). Do NOT break left side preformed blanking element. Then insert and fix the cover on screw output terminal by means of M6 nylon-capped lock nut.

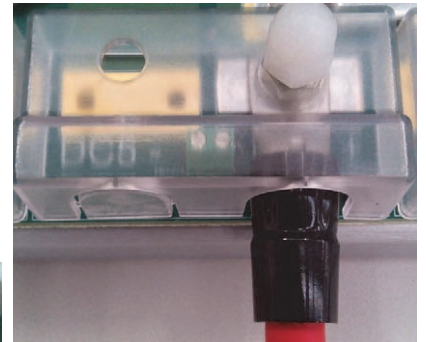
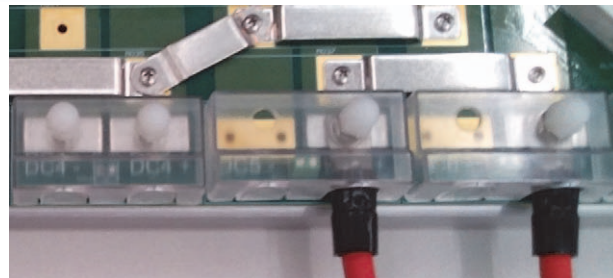

Fig. 15



After having wired all DC output lines, starting from position 1 to position 6 (excluding position 3 and 4 because cannot be used), tighten 2 top screws of each PSM1250 as shown in **Fig. 16**.

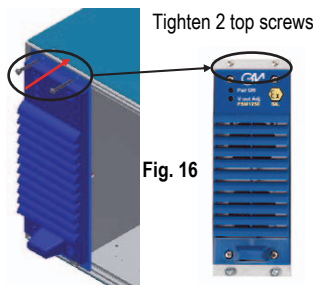

Fig. 16

Now power **AC1 and AC2 input power lines**.

PSO1250 diagnostic module (if it's present) and each PSM1250 power module turn on and the PSS1250-HS-7-48-D system DC output lines will power the load.

Installation Procedure - 4th step (for models without HS) - Section A: Installation and start up of PSO1250 Diagnostic Module

Insert the PSO1250 diagnostic module in the last position (7th) on the right of the Rack unit and fix the module to the Rack unit by means of its 4 screws on its front side.

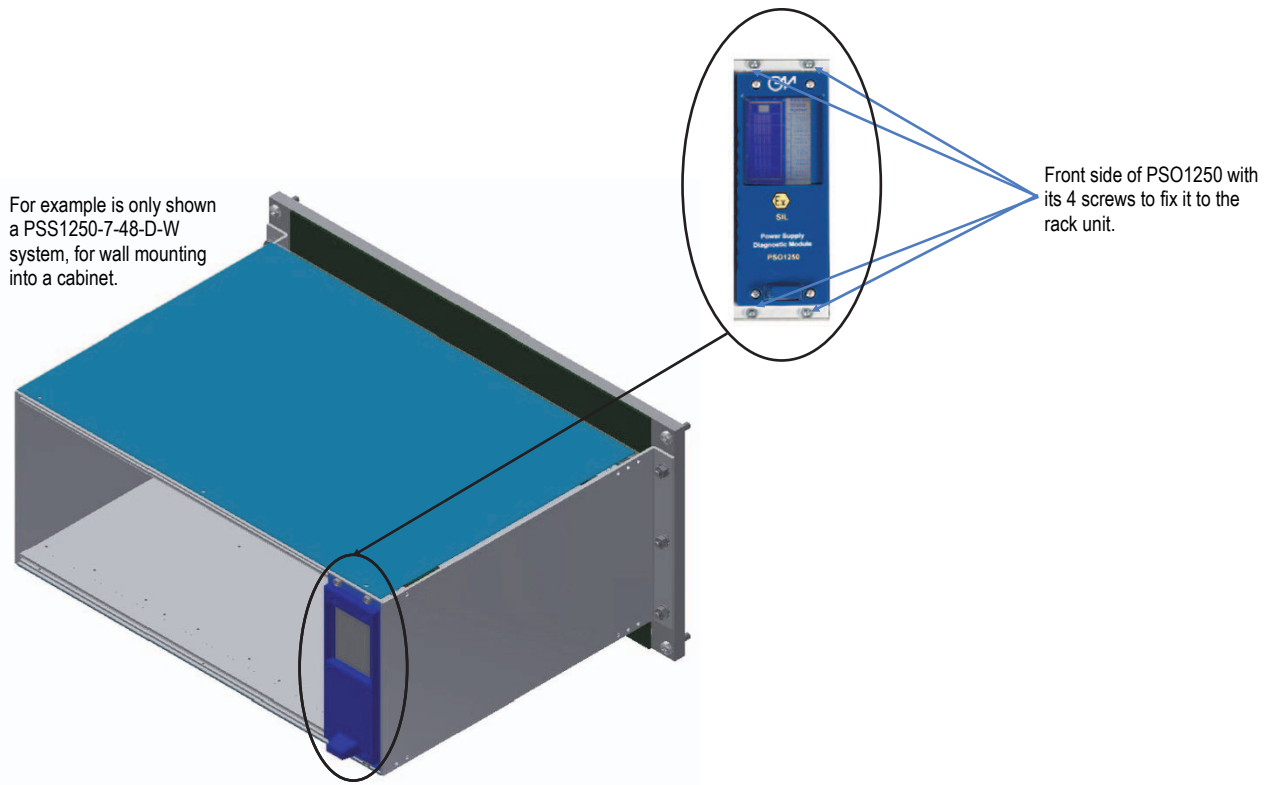

After installation of the PSO1250 module, **power AC1 and AC2 input power lines** in order to turn on the diagnostic module.
For more information about diagnostic module features and its set up, please see description from page 26.
After setting up the PSO1250 module, **unpower AC1 and AC2 input power lines**.

Installation Procedure - 4th step (for models without HS) - Section B: Installation and pre-start up of PSM1250 Power Supply Module

This step could be not executed if PSS1250-7-48-D output voltage factory setting to 48 Vdc is corrected for your applications. Instead, execute this step if it's necessary to set up a different value for PSS1250-7-48-D output voltage in the range 42 to 56 Vdc.

AC1 and AC2 input power lines are unpowered.

The following procedure is split in **3 sub-steps** and it is the same for each PSM1250, independently from its position in the Rack unit. Starting from position 1 to position 6 (excluding position 3 and 4 because cannot be used), execute pre-start up of each PSM1250 module.

1st sub-step: insert and fix the PSM1250 module into the Rack unit by means of its 4 screws on its front side.

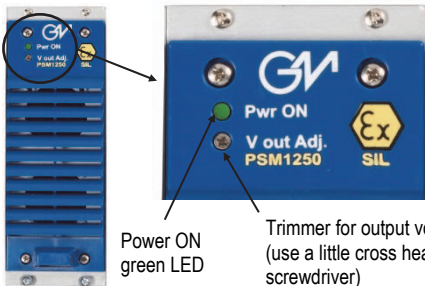
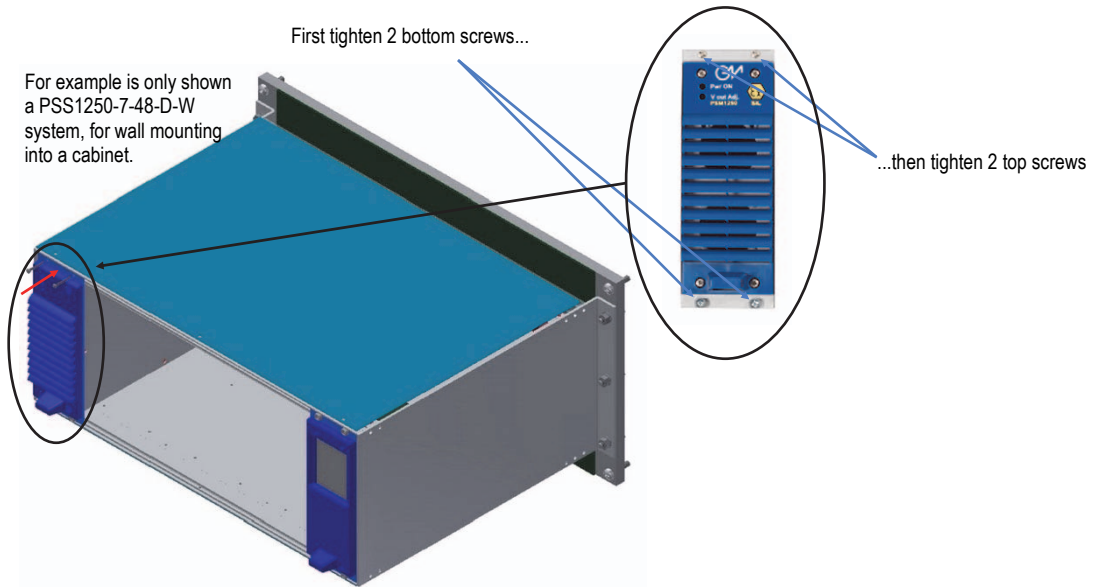

Power ON green LED

Trimmer for output voltage adjusting (use a little cross head isolated screwdriver)

2nd sub-step: powering AC1 and AC2 input power lines, PSM1250 module is turn on, its front panel Power ON green LED is ON and 24 Vdc (factory setting) output voltage is present on PSM1250 screw output terminals DC- and DC+ (see page 7 for more information about Power ON green LED signalling). The output voltage can be measured on PSM1250 screw output terminals by means of a multimeter. In addition, on the TFT color screen of PSO1250 diagnostic module it is possible to monitor the PSM1250 module status and to collect information about the power supply: for example output voltage value (see description from page 26). If it is required to set an output voltage value different from factory setting (24 Vdc), use the trimmer for output voltage adjusting. Turn the trimmer clockwise (to the right) to increase output voltage (max. 28 Vdc) or turn the trimmer counterclockwise (to the left) to decrease output voltage (min. 21 Vdc). To set PSS1250-7-48-D output voltage to V_out-system value in the range 42 to 56 Vdc, then V_out-PSM must be set to V_out-system / 2 value, because two groups have their outputs connected in series and each group is composed by 2 PSM1250 with paralleled outputs and with load sharing circuits. **Warning:** for correct current sharing operation in a group, power supply modules of a group must have output voltages calibrated within ± 0.5 V.

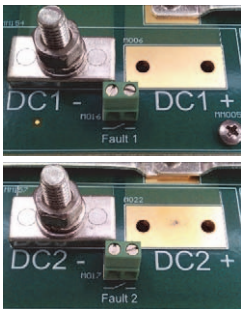

1st PSM1250 screw output terminals on copper bars:
DC1- is its negative out pole,
DC1+ is its positive out pole.

DC1- and DC2- are also negative out poles of PSS1250-7-48-D.

2nd PSM1250 screw output terminals on copper bars:
DC2- is its negative out pole,
DC2+ is its positive out pole.

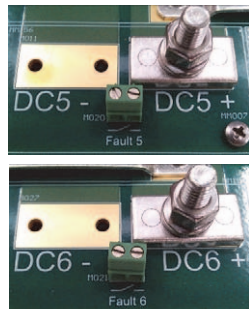

5th PSM1250 screw output terminals on copper bars:
DC5- is its negative out pole,
DC5+ is its positive out pole.

DC5+ and DC6+ are also positive out poles of PSS1250-HS-7-48-D.

6th PSM1250 screw output terminals on copper bars:
DC6- is its negative out pole,
DC6+ is its positive out pole.

3rd sub-step: after having adjusted the PSM1250 output voltage, **unpower AC1 and AC2 input power lines** to turn off the power module. Then release 4 screws on its front side and disconnect the module from the Rack unit in order to repeat **sub-steps 1 to 3** procedure for other modules and complete the setting for all PSM1250 of PSS1250 power system.

In this figure only the 1st PSM1250 module is shown but the same disconnection procedure is also applicable to other PSM1250 modules.

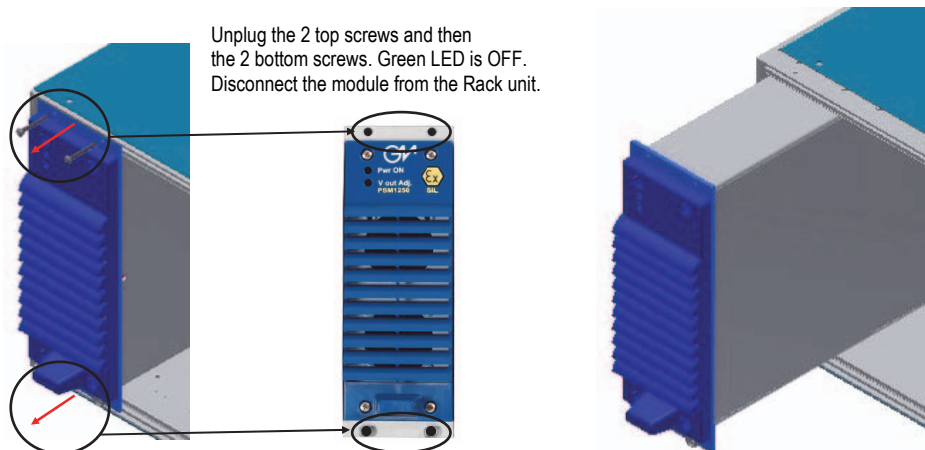

Installation Procedure - 4th step (for models without HS) - Section C: Wiring of 1st & 2nd PSM1250 screw output terminals on copper bars of Back Panel PCB (PSS1250-HS negative DC out lines)

At this step **AC1 and AC2 input power lines are unpowered**, PSO1250 diagnostic module (if it's present) is installed and fixed to Rack unit with 4 screws, while all PSM1250 modules are disconnected. Starting from position 1 to position 6 (excluding position 3 and 4 because cannot be used), insert and fix each PSM1250 module into the Rack unit by means of its 4 screws on its front side.

For example is only shown a PSS1250-7-48-D-W system, for wall mounting into a cabinet.

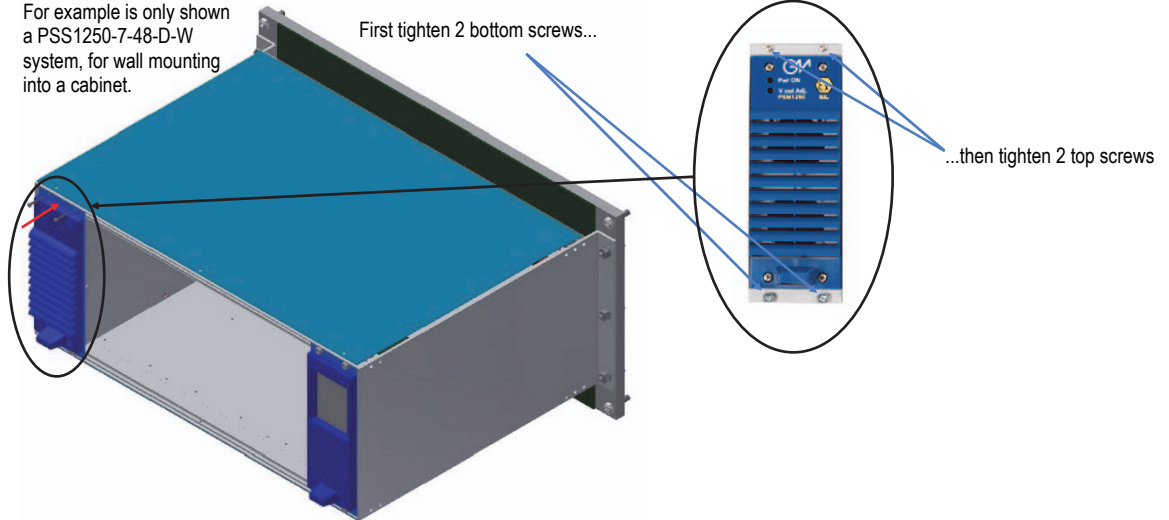

To wire negative DC output lines (DC1- and DC2- screw output terminals) of PSS1250 system, see Fig. 17-18-19-20-21. See functional diagrams on pages 7 about wiring connection.

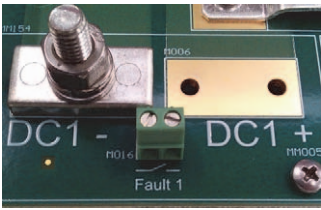

Fig. 17

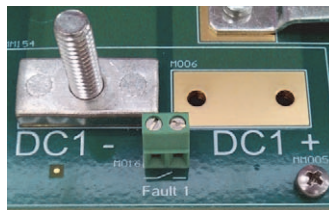

Fig. 18

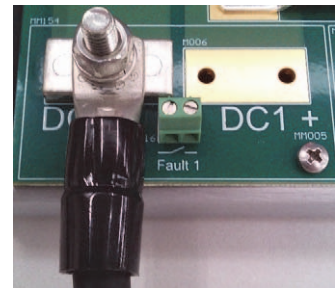
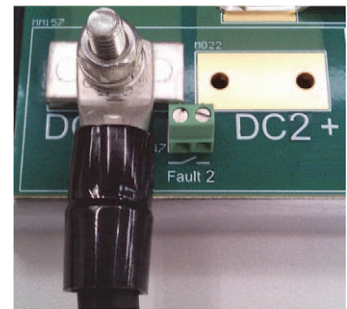
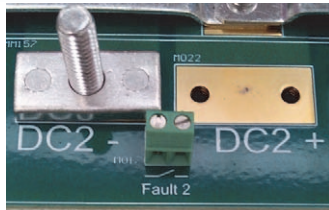

Fig. 19



Unplug M6 nut, groover and washer. Then insert the cable lug (at least 6.5 mm hole diameter) with wire (negative out wire of PSS1250 system), washer and groover on the screw output terminal. Finally tighten nut to fix wire.



For DC screw output terminals, use a cable section range from 6AWG (or 13 mm²) to 5AWG (or 16 mm²) and tighten M6 nut+groover+washer on screw with maximum 4 Nm torque.

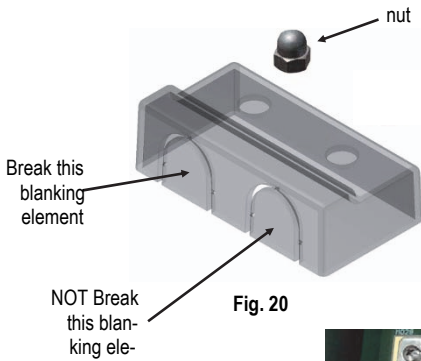
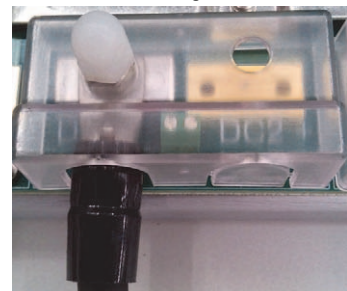
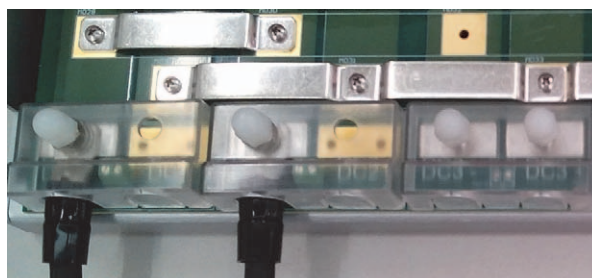

Fig. 20

A polycarbonate cover is used for IP20 to protect each couple of screw output terminals. Break only left side preformed blanking element to allow cable passage (negative out wire of PSS1250 system). Do NOT break right side preformed blanking element. Then insert and fix the cover on screw output terminal by means of M6 nylon-capped lock nut.



Fig. 21



Installation Procedure - 4th step (for models without HS) - Section D: Wiring of 5th & 6th PSM1250 screw output terminals on copper bars of Back Panel PCB (PSS1250-HS positive DC out lines) & PSS start-up

At this step, **AC1 and AC2 input power lines are unpowered**, PSO1250 diagnostic module (if it's present) and all PSM1250 modules are installed and fixed to Rack unit with 4 screws.

To wire positive DC output lines (DC5+ and DC6+ screw output terminals) of PSS1250 system, see **Fig. 22-23-24-25-26**. See functional diagrams on pages 7 about wiring connection.



Fig. 22

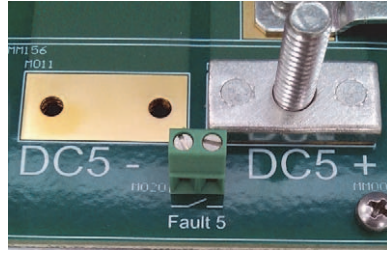
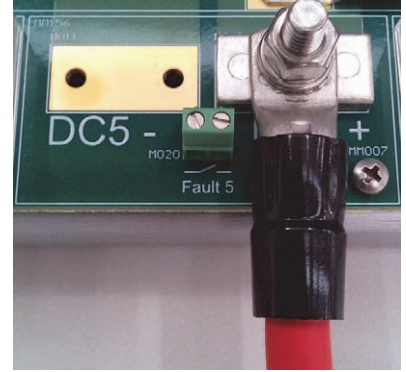

Fig. 23



Unplug M6 nut, groover and washer. Then insert the cable lug (at least 6.5 mm hole diameter) with wire (positive out wire of PSS1250 system), washer and groover on the screw output terminal. **Fig.24** Finally tighten nut to fix wire.

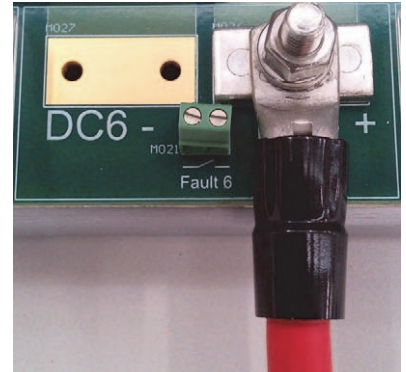
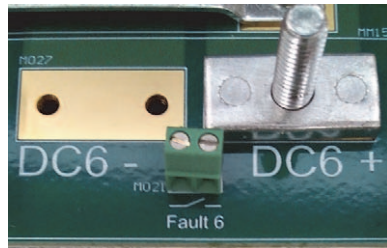
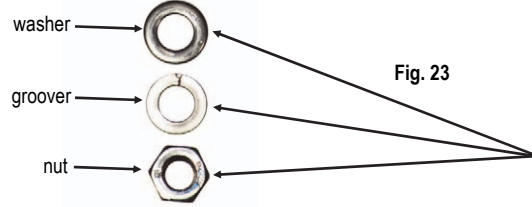
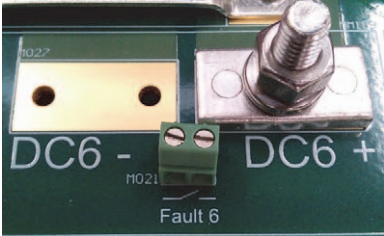

Fig. 26

For DC screw output terminals, use a cable section range from 6AWG (or 13 mm²) to 5AWG (or 16 mm²) and tighten M6 nut+groover+washer on screw with maximum 4 Nm torque.

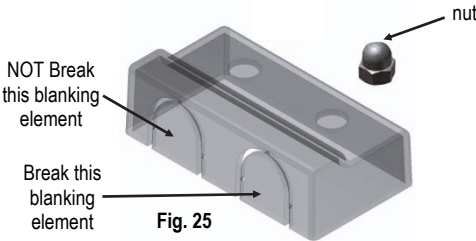
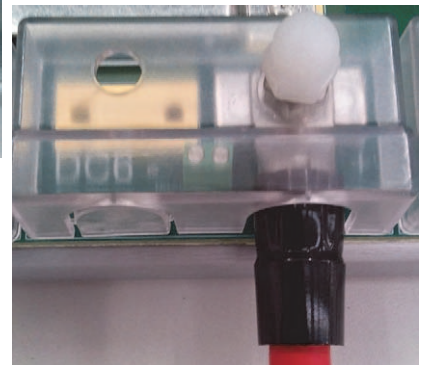
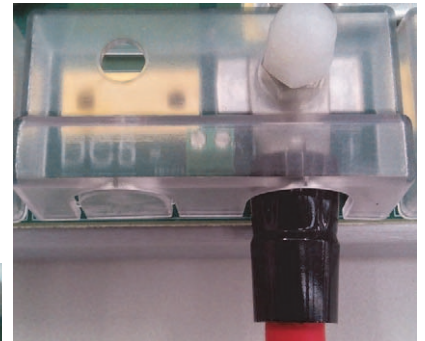
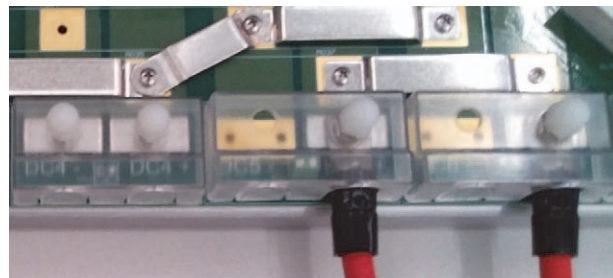

Fig. 25

A polycarbonate cover is used for IP20 to protect each couple of screw output terminals. Break only right side preformed blanking element to allow cable passage (positive out wire of PSS1250 system). Do NOT break left side preformed blanking element. Then insert and fix the cover on screw output terminal by means of M6 nylon-capped lock nut.



After having wired all DC output lines, **power AC1 and AC2 input power lines**.

PSO1250 diagnostic module (if it's present) and each PSM1250 power module turn on and the PSS1250-7-48-D system DC output lines will power the load.

Shutdown and Disconnecting Procedure of PSM1250 power module from the Rack unit : - for models with HS

Disconnection of PSM1250 module from the Rack unit, can be done without switching off the power from AC1 and AC2 lines, because of the fully redundant configuration from the input to the output of the power system.

To remove a PSM1250 power module unplug the 2 top screws and then release the other 2 bottom screws.

Check that Power ON LED is OFF before disconnecting the module from the rack unit.

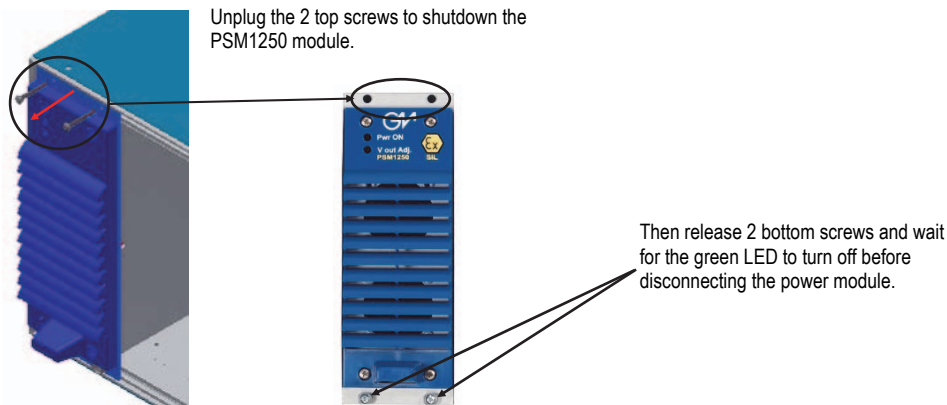

Shutdown and Disconnecting Procedure of PSM1250 power module from the Rack unit : - for models without HS

Disconnection of PSM1250 module from the Rack unit, must be done by switching off the power from AC line that supplies PSM1250 module, which does not imply shutdown of whole system because of the fully redundant configuration from the input to the output of the power system.

To remove a PSM1250 power module release 4 screws on its front side and disconnect the module from the Rack unit.

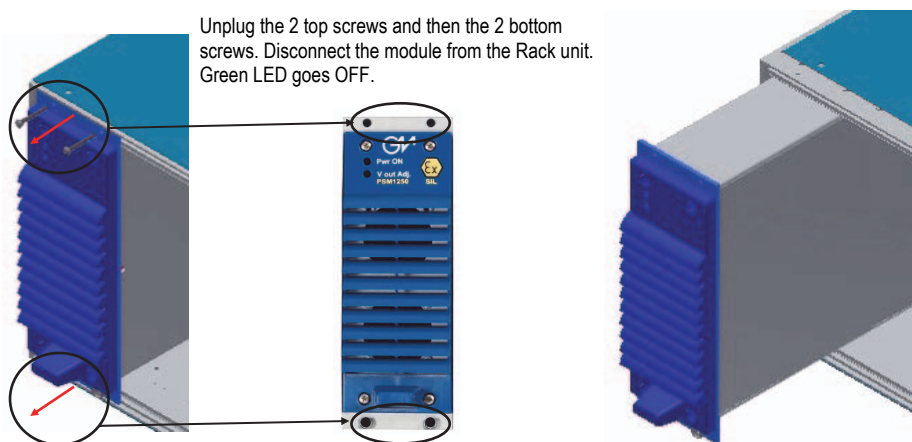

Replacement Procedure of PSM1250 power module from the Rack unit (for models with or without HS)

To disconnect a PSM1250 module from the Rack unit, follow the previous procedure "Shutdown and disconnecting procedure of PSM1250 power module from the rack unit (for models with or without HS)" to unplug the PSM1250 module.

Then, take a new PSM1250 power module and follow this procedure steps: 1 2 3

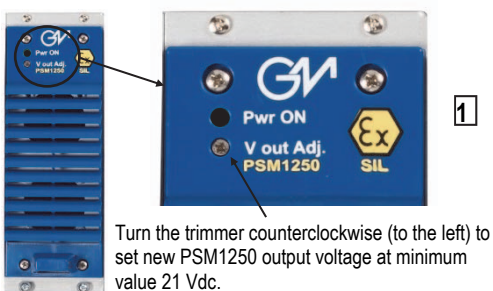

Then insert and fix the new PSM1250 module into the Rack unit by means of its 4 screws on front side. First tighten 2 bottom screws and then tighten 2 top ones.

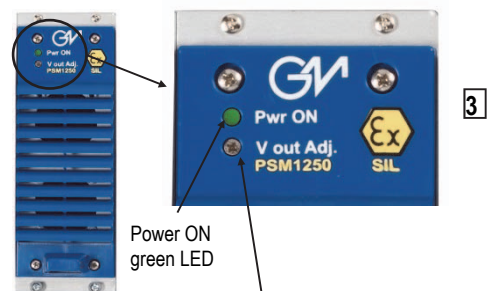
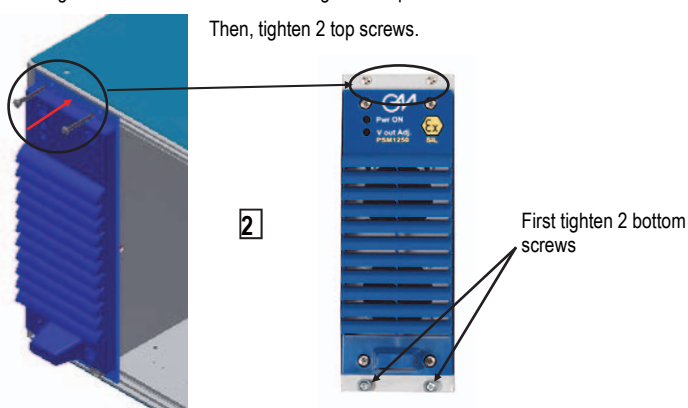

The new PSM1250 module is powered and its green LED is ON, but the module is not operating in current sharing with other PSM1250 module (of the same group) paralleled with it, because its output voltage is too low (21 Vdc). For correct current sharing operation in a group, power supply modules of a group must have output voltages calibrated within ± 0.5 V.

The output voltage can be measured on PSM1250 screw output terminals by means of a multimeter. In addition, on the TFT color screen of PSO1250 diagnostic module it is possible to monitor the PSM1250 module status and to collect information about the power supply: for example output voltage value (see description from page 26). Then slowly increase output voltage with the trimmer to reach the output voltage (within ± 0.5 V) of other PSM1250 module (of the same group) paralleled with it, to guarantee a correct current sharing operation.

Slowly turn the trimmer clockwise (to the right) to increase new PSM1250 output voltage and reach the output voltage (within ± 0.5 V) of other PSM1250 module (of the same group) paralleled with it.

PSO1250 Diagnostic Module: features and set up

Communication with four power modules is achieved via PSO1250 diagnostic module, which incorporates a front panel color touch screen. The diagnostic module is able to query each power modules (using an internal proprietary bus) and read data such as: Input/Output Voltage, Current and Power; Input Line Frequency; Output current sharing percentage; Current sharing group; Internal Temperature; alarm status (under/over out voltage, AC line absence, internal PFC or PWM stage in OFF state, internal high temperature, fans malfunction). These information are available via front panel LCD and externally via Modbus RTU on related wall mounting terminal block.

The following figures are screenshots of TFT LCD and show the setting up of the PSO1250 diagnostic module and reading data from each power module.



At start up of PSO1250 diagnostic module, this image is shown for some seconds.

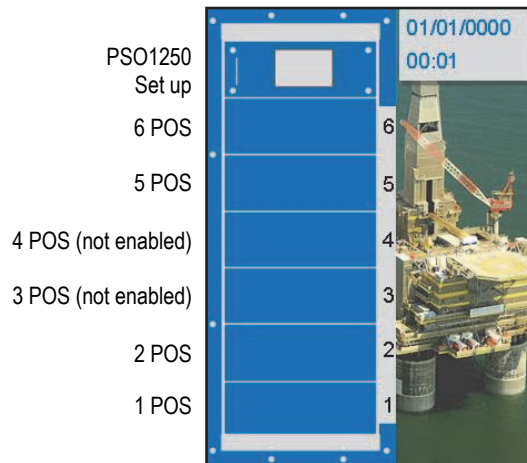

This image is PSS1250-xx-7-48-D main menu, when no PSM1250 module is operating in power system.

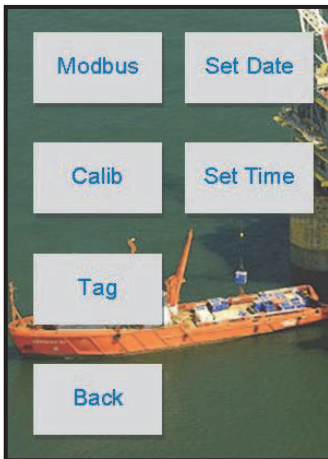

This set up menu image is shown when touching the "PSO1250 set up" cell in the main menu screen.

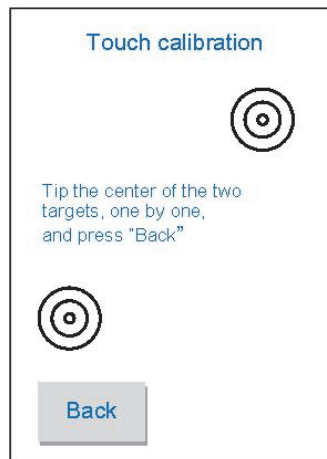

This image is shown when touching the "Calib" cell in the set up menu screen. Tip the center of the two targets, one by one, and press back, for calibration of touch screen.



This image is shown when touching the "Modbus" cell in the set up menu screen. Here is possible to set Modbus communication parameters as baudrate, parity, terminal resistance, endianness and address, touching related cells. These parameters are saved in PSO1250 memory and also held after AC1 and AC2 supply shutdown.

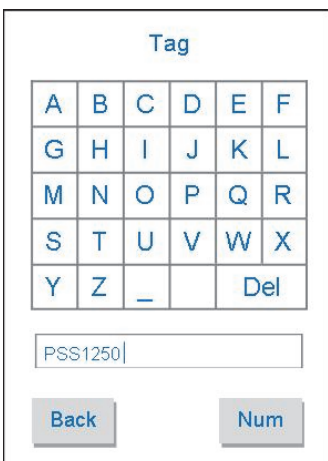

This image is shown when touching the "Tag" cell in the set up menu screen. Alphabetical board to introduce a tag to identify PSS1250. The Tag is saved in PSO1250 memory and also held after AC1 and AC2 supply shutdown.

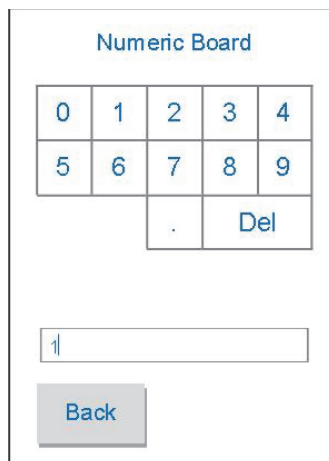

This image (numeric board) is shown when touching the "Addr" cell in Modbus menu or "Num" cell in Tag menu screen. Modbus Address value must be included in the 1 to 247 range.



This image is shown when touching the "Set Date" cell in the set up menu screen. Here is possible to set Day, Month and Year touching related cells. Date format is day/month/year (as dd/mm/yyyy). Current setting is shown in numeric format. Date is not kept after AC1 and AC2 supply shutdown.

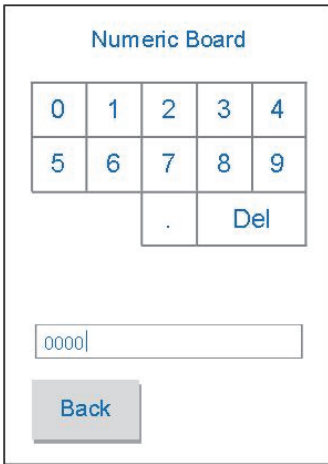

This image (numeric board) is shown when touching the "Set Year" cell in the Date menu screen. Year value must be expressed by 4 digits.

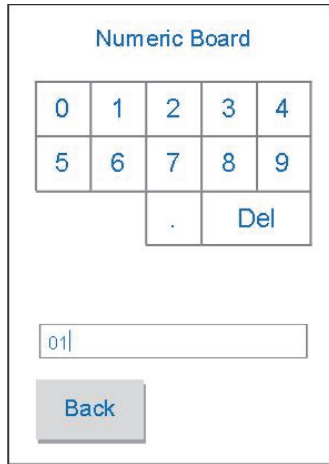

This image (numeric board) is shown when touching the "Set Day" - "Set Mon" cell in the Date menu screen or the "Set Hour" - "Set Min" cell in the Time menu screen. This value must be expressed by 2 digits.



This image is shown when touching the "Set Time" cell in the set up menu screen. Here is possible to set Hour and Minute touching related cells. 24 hours Time format is hour:minute (as hh:mm). Current setting is shown in numeric format. Time is not kept after AC1 and AC2 supply shutdown.

Different green colors for each current sharing group.

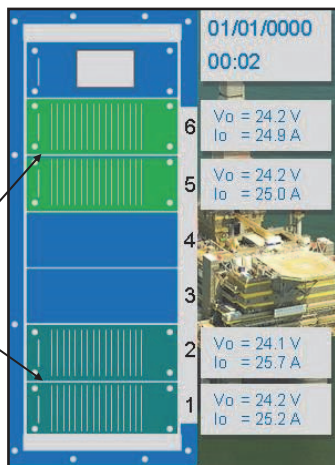

All PSM1250 modules are normally operating (their pos. cells are all green, with different shade of green for each current sharing group).

This image is related to PSS1250-xx-7-48-D where there are 2 current sharing groups: 1 & 2 ; 5 & 6 .

For each operating PSM1250 module, on the right of its "x POS" cell, there is a label that shown:

- Vo , its out voltage before active ideal diode (which is different from out DC or out group voltage);
- Io , its out current or out DC current.

On the screen, the PSS1250-xx-7-48-D output voltage (typical 48 Vdc with possible range 42 to 56 Vdc) cannot be seen but it can be indirectly deduced by adding 1st group (1 & 2) output voltage to 2nd group (5 & 6) output voltage. Indeed, each group output voltage is typical 24 Vdc with possible range 21 to 28 Vdc.

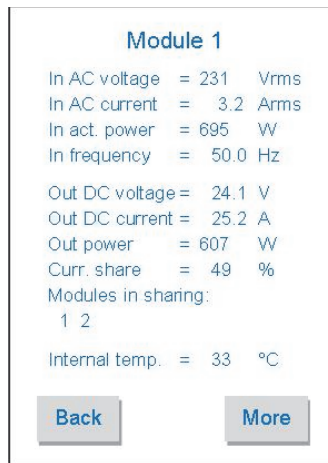

Touching "1 POS" cell on the main menu screen, PSM1250 module 1 (Pos.1) first page data are shown: Input AC Voltage and Current, Input Active Power, Input Line Frequency, Output DC or out group Voltage (after active ideal diode), Output DC Current, Output Power, Output current sharing percentage, Current sharing group (modules 1 and 2 are in sharing), Internal Temperature.

Touch "Back" cell to return on the main menu or touch "More" cell to go on the module second page data.

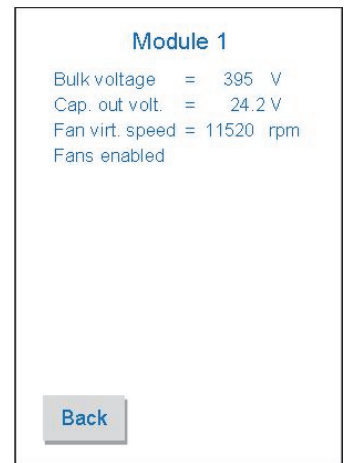

This is PSM1250 module 1 (Pos.1) second page where other data are shown: Bulk Voltage or internal PFC capacitor voltage, Capacitor out voltage or out voltage before active ideal diode, Fan virtual (or set) speed, indication if fans are enabled or disable. In addition, this page is used to show fault alarm as: under/over out voltage, AC line absence, internal PFC or PWM stage in OFF state, internal high temperature, fans malfunction). Touch "Back" cell to return on the module first page.

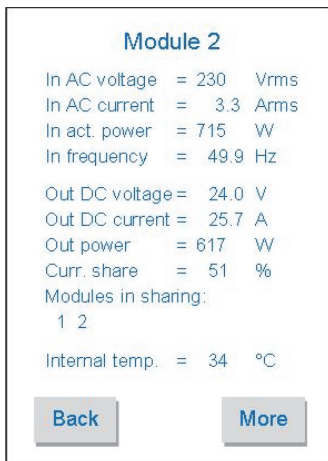

Touching "2 POS" cell on the main menu screen, PSM1250 module 2 (Pos.2) first page data are shown. Modules 1 and 2 are in sharing. Touch "Back" cell to return on the main menu or touch "More" cell to go on the module second page data.

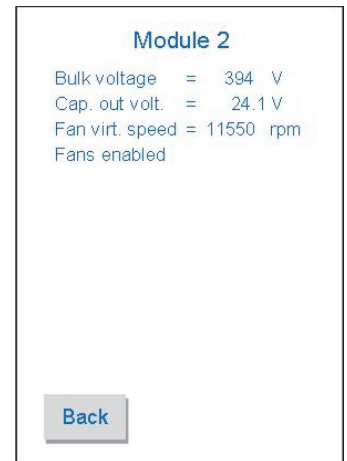

This is PSM1250 module 2 (Pos.2) second page where other data are shown. Touch "Back" cell to return on the module first page.

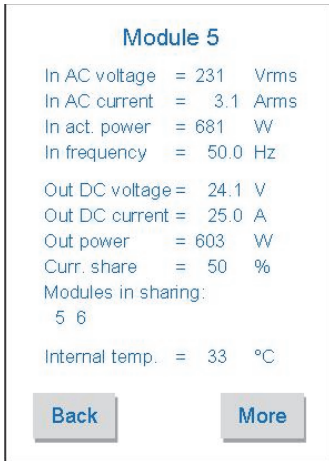

Touching "5 POS" cell on the main menu screen, PSM1250 module 5 (Pos.5) first page data are shown. Modules 5 and 6 are in sharing. Touch "Back" cell to return on the main menu or touch "More" cell to go on the module second page data.

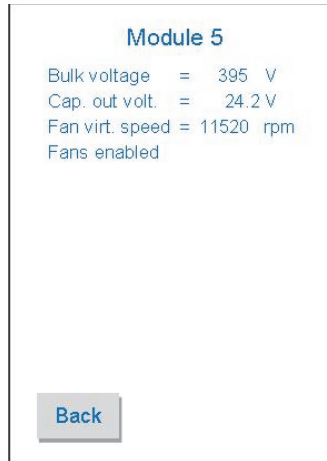

This is PSM1250 module 5 (Pos.5) second page where other data are shown. Touch "Back" cell to return on the module first page.

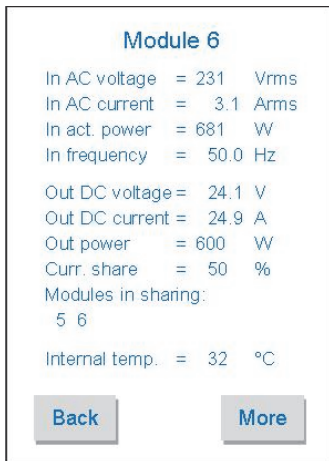

Touching "6 POS" cell on the main menu screen, PSM1250 module 6 (Pos.6) first page data are shown. Modules 5 and 6 are in sharing. Touch "Back" cell to return on the main menu or touch "More" cell to go on the module second page data.

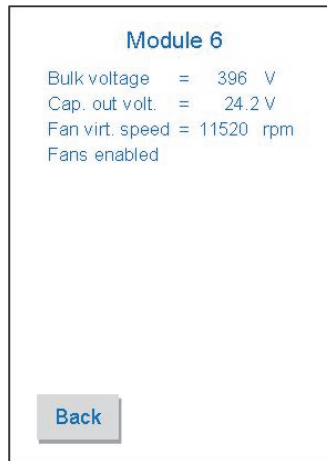

This is PSM1250 module 6 (Pos.6) second page where other data are shown. Touch "Back" cell to return on the module first page.

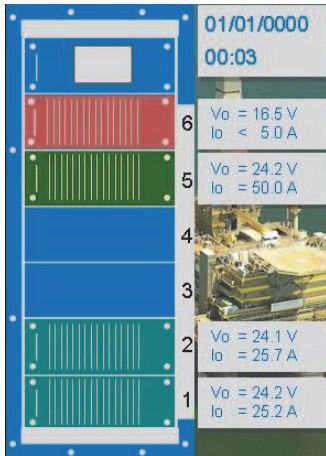

The PSM1250 module 6 (Pos.6) is in fault condition because its "6 POS" cell on the main menu screen is red. Its Vo out voltage before active ideal diode is 16.5 V < 24.2 V and its Io out current is < 5 A < 24.9 A . Therefore module 6 does not contribute to supply the 5 & 6 group load. Now, only module 5 (Pos.5) drives the 5 & 6 group load because its Io out current is increased from 25.0 to 50.0 A.

Module 6

Bulk voltage = 232 V
 Cap. out volt. = 16.5 V
 Fan virt. speed = 5850 rpm
 Fans enabled

Faults

Output under - volt

Input AC off

PFC stage off
 PWM stage off

Back

The PSM1250 module 6 (Pos.6) is in fault condition because of: AC line absence which implies internal PFC and PWM stages in OFF state and output under-voltage (16.5 V < 20 V bottom limit).

Module 6

In AC voltage = 13 Vrms
 In AC current = 0.0 Arms
 In act. power = 0 W
 In frequency > 0.0 Hz

Out DC voltage = 24.1 V
 Out DC current < 5.0 A
 Out power < 120 W
 Curr. share = 0 %

Modules in sharing:
 5 6

Internal temp. = 33 °C

Back **More**

Capacitor out voltage or out voltage before active ideal diode is 16.5 V but out DC or out group voltage (after active ideal diode) is 24.1 V. Module 6 does not contribute to supply the 5 & 6 group load and its out current sharing percentage is 0%. Out current and power measure at low load (< 5 A) is not accurate so that: Out DC current < 5 A and Out power < 120W.

Module 5

In AC voltage = 229 Vrms
 In AC current = 6.2 Arms
 In act. power =1378 W
 In frequency = 50.0 Hz

Out DC voltage = 24.1 V
 Out DC current = 50.0 A
 Out power =1205 W
 Curr. share = 100 %

Modules in sharing:
 5 6

Internal temp. = 33 °C

Back **More**

The PSM1250 module 5 (Pos.5) drives the 5 & 6 group load because its Io out current is increased from 25.0 to 50.0 A and its out current sharing percentage is 100%.

Module 5

Bulk voltage = 386 V
 Cap. out volt. = 24.2 V
 Fan virt. speed = 16245 rpm
 Fans enabled

Back

Now, Fan virtual (or set) speed is increased from 11520 to 16245 rpm because of out power increment. Indeed, fan speed control depending on output power and ambient temperature.

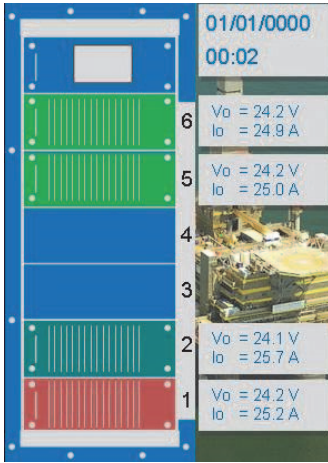

The PSM1250 module 1 (Pos.1) is in fault condition because its "1 POS" cell on the main menu screen is red. Its Vo out voltage before active ideal diode and its Io out current are seemingly correct. The answer is shown in the module second page, which resumes fault alarms.

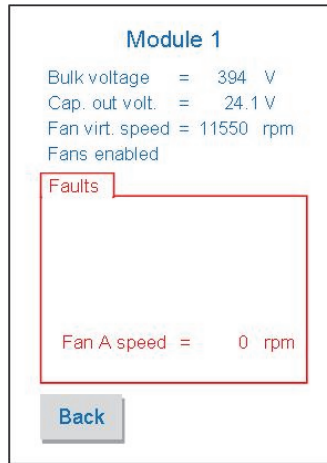

The fault is due to Fan A malfunction, because its speed is 0 < 11550 rpm setting, that is Fan A does not work.

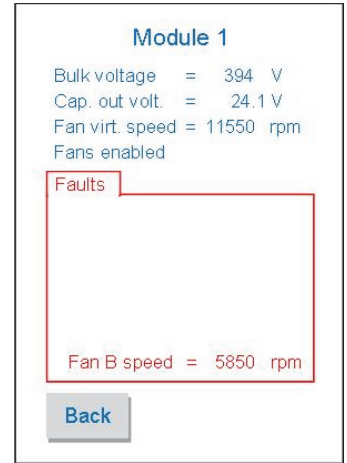

The fault is due to Fan B malfunction, because its speed is 5850 < 11550 rpm setting, that is Fan B works but not correctly. When speed difference between setting speed value and read speed value is more in absolute to 5000 rpm a fan fault is shown, specifying speed reading.

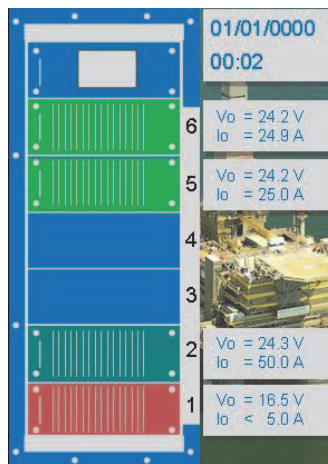

The PSM1250 module 1 (Pos.1) is in fault condition because its "1 POS" cell on the main menu screen is red. Its Vo out voltage before active ideal diode is 16.5 V < 24.2 V and its Io out current is < 5 A < 25.2 A. Therefore module 1 does not contribute to supply the 1 & 2 group load. Now, only module 2 (Pos.2) drives the 1 & 2 group load because its Io out current is increased from 25.7 to 50.0 A.

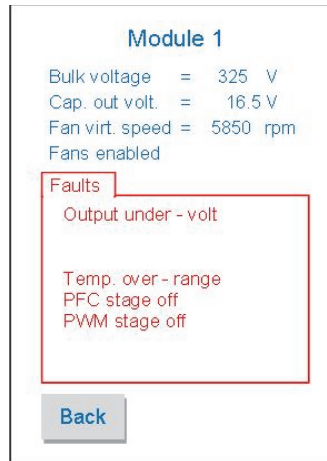

The PSM1250 module 1 (Pos.1) is in fault condition because of: internal temperature over-range, which imposes thermal shutdown of internal PFC and PWM stages, implying output under-voltage (16.5 V < 20 V bottom limit). Note that AC line is present and fans go on to work at low speed in order to cool whole module.

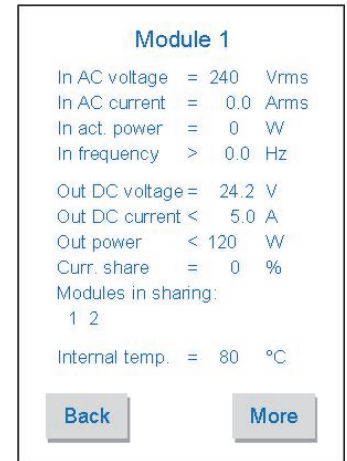

Indeed, module 1 internal temperature is 80°C, higher than 75°C. The module has thermal hysteresis and it removes internal temperature over-range fault when its internal temperature is reduce under 70°C. AC line is present and its voltage is 240 Vrms. Module 1 does not contribute to supply the 1 & 2 group load and its out current sharing percentage is 0%.

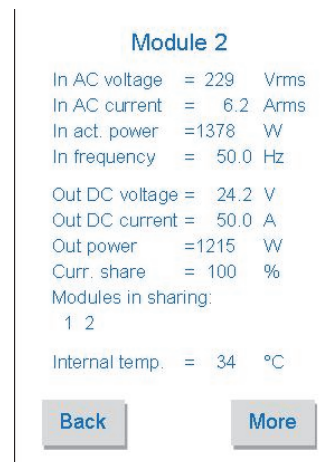

The PSM1250 module 2 (Pos.2) drives the 1 & 2 group load because its Io out current is increased from 25.7 to 50.0 A and its out current sharing percentage is 100%.

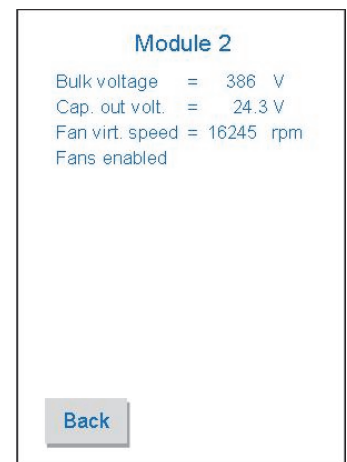

Now, Fan virtual (or set) speed is increased from 11550 to 16245 rpm because of out power increment. Indeed, fan speed control depending on output power and ambient temperature.

Supported Modbus parameters: functions and details

Below is a list of all available registers for communication via Modbus RTU RS-485 protocol.

Addr.	Description	Notes	Type ⁽¹⁵⁾	Addr.	Description	Notes	Type ⁽¹⁵⁾
0	G.M. Factory Code	Identification Data	R	159	PSM1250 Internal temperature ⁽²⁾	5th position PSM1250 Module Data	R
1	Instrument Code			160	Input active power ⁽³⁾		
2	Option Code			161	Output power ⁽³⁾		
3	Hardware Release			162	Power efficiency ⁽⁴⁾		
4	Software Release	163	Bulk electrolytic capacitor voltage ⁽⁵⁾				
16	Modbus Address	Communication Data	R/W	164	AC input voltage ⁽⁶⁾		
17	Modbus Baudrate ⁽¹⁾			165	AC input current ⁽⁷⁾		
18	Modbus Format ⁽¹⁾			166	AC input frequency ⁽⁸⁾		
71	PSM1250 Internal temperature ⁽²⁾	1st position PSM1250 Module Data	R	167	Primary side fault information ⁽¹⁾		
72	Input active power ⁽³⁾			169	Output electrolytic capacitor voltage ⁽⁹⁾		
73	Output power ⁽³⁾			170	Output voltage ⁽⁹⁾		
74	Power efficiency ⁽⁴⁾			171	Output current ⁽¹⁰⁾		
75	Bulk electrolytic capacitor voltage ⁽⁵⁾			172	Fan driver enable ⁽¹⁾		
76	AC input voltage ⁽⁶⁾			173	Fan driver inverted duty cycle ⁽¹³⁾		
77	AC input current ⁽⁷⁾			174	Fan driver speed ⁽¹¹⁾		
78	AC input frequency ⁽⁸⁾			175	Fan A read frequency ⁽¹²⁾		
79	Primary side fault information ⁽¹⁾			176	Fan A read speed ⁽¹¹⁾		
81	Output electrolytic capacitor voltage ⁽⁹⁾			177	Fan B read frequency ⁽¹²⁾		
82	Output voltage ⁽⁹⁾			178	Fan B read speed ⁽¹¹⁾		
83	Output current ⁽¹⁰⁾			179	Secondary side fault information ⁽¹⁾		
84	Fan driver enable ⁽¹⁾			180	Secondary side extra fault information ⁽¹⁾		
85	Fan driver inverted duty cycle ⁽¹³⁾			181	PSM1250 Internal temperature ⁽²⁾		
86	Fan driver speed ⁽¹¹⁾			182	Input active power ⁽³⁾		
87	Fan A read frequency ⁽¹²⁾			183	Output power ⁽³⁾		
88	Fan A read speed ⁽¹¹⁾			184	Power efficiency ⁽⁴⁾		
89	Fan B read frequency ⁽¹²⁾			185	Bulk electrolytic capacitor voltage ⁽⁵⁾		
90	Fan B read speed ⁽¹¹⁾			186	AC input voltage ⁽⁶⁾		
91	Secondary side fault information ⁽¹⁾			187	AC input current ⁽⁷⁾		
92	Secondary side extra fault information ⁽¹⁾	188	AC input frequency ⁽⁸⁾				
93	PSM1250 Internal temperature ⁽²⁾	2nd position PSM1250 Module Data	R	189	Primary side fault information ⁽¹⁾		
94	Input active power ⁽³⁾			191	Output electrolytic capacitor voltage ⁽⁹⁾		
95	Output power ⁽³⁾			192	Output voltage ⁽⁹⁾		
96	Power efficiency ⁽⁴⁾			193	Output current ⁽¹⁰⁾		
97	Bulk electrolytic capacitor voltage ⁽⁵⁾			194	Fan driver enable ⁽¹⁾		
98	AC input voltage ⁽⁶⁾			195	Fan driver inverted duty cycle ⁽¹³⁾		
99	AC input current ⁽⁷⁾			196	Fan driver speed ⁽¹¹⁾		
100	AC input frequency ⁽⁸⁾			197	Fan A read frequency ⁽¹²⁾		
101	Primary side fault information ⁽¹⁾			198	Fan A read speed ⁽¹¹⁾		
103	Output electrolytic capacitor voltage ⁽⁹⁾			199	Fan B read frequency ⁽¹²⁾		
104	Output voltage ⁽⁹⁾			200	Fan B read speed ⁽¹¹⁾		
105	Output current ⁽¹⁰⁾			201	Secondary side fault information ⁽¹⁾		
106	Fan driver enable ⁽¹⁾			202	Secondary side extra fault information ⁽¹⁾		
107	Fan driver inverted duty cycle ⁽¹³⁾			203	Current sharing value ⁽⁴⁾		
108	Fan driver speed ⁽¹¹⁾			204	Current sharing value ⁽⁴⁾		
109	Fan A read frequency ⁽¹²⁾			207	Current sharing value ⁽⁴⁾		
110	Fan A read speed ⁽¹¹⁾			208	Current sharing value ⁽⁴⁾		
111	Fan B read frequency ⁽¹²⁾			209	Current sharing group with 1st PSM ⁽¹⁾		
112	Fan B read speed ⁽¹¹⁾			210	Current sharing group with 2nd PSM ⁽¹⁾		
113	Secondary side fault information ⁽¹⁾			213	Current sharing group with 5th PSM ⁽¹⁾		
114	Secondary side extra fault information ⁽¹⁾	214	Current sharing group with 6th PSM ⁽¹⁾				
		464	Command execution ⁽¹⁴⁾	Command	W		
		516	Inter-modules communic. error counter	Inter-modules protocol	R		
		517	Inter-modules missed communication ⁽¹⁾	Inter-modules protocol	R		
		518	Modbus error counter	Modbus protocol	R		
		533	Common fault status ⁽¹⁾	Common fault data	R		

(To be continued on next page)

Supported Modbus parameters:

Addr.	Description	Notes	Type ⁽¹⁴⁾
556	Chars 0, 1	PSS1250 Tag	R/W
557	Chars 2, 3		
558	Chars 4, 5		
559	Chars 6, 7		
560	Chars 8, 9		
561	Chars 10, 11		
562	Chars 12, 13		
563	Chars 14, 15		

Supported modbus functions:

Code	Name	Notes
03	read holding registers	reads a stream of words from memory
04	read input registers	reads a stream of words from memory
08	diagnostics: subcode 0	returns query data
06	write single register	writes a word in memory
16	write multiple registers	writes a stream of words in memory

Notes:

Each Modbus parameter is described by one 16-bit word.

- See command details on this page.
- Expressed in °C.
- Expressed in W.
- Expressed in %.
- Expressed in V.
- Expressed in Vrms.
- Expressed in 100 mArms.
- Expressed in 100 mHz.
- Expressed in 100 mV.
- Expressed in 100 mA.
- Expressed in Round Per Minute (RPM).
- Expressed in Hz.
- Expressed in %: inverted duty cycle (%) = 100% - duty cycle (%).
- All configurations must be confirmed via Addr. 464, see details on this page.
- Parameter Type: R = read only; W = write only; R/W = read and write.

Modbus parameters details:

Address 17: Supported Modbus Baudrates	
Index	Baudrate
0	4800
1	9600
2	19200
3	38400
4	57600
5	115200

Address 18: Supported Modbus Formats	
High Byte	Low Byte
Bit position	
15 14 13 12 11 10 9 8 7 6 5 4 3 2	1 0
Endianness 32 bit Data (0 = Little; 1 = Big)	
Termination resistance (1 = enabled)	
Supported Modbus Parity:	
0 8 data bit, no parity, 1 stop bit	
1 8 data bit, even parity, 1 stop bit	
2 8 data bit, odd parity, 1 stop bit	

Address 79: (1st PSM1250)		Primary side fault information
Address 101: (2nd PSM1250)		
Address 167: (5th PSM1250)		
Address 189: (6th PSM1250)		
High Byte		Low Byte
Bit position		
15 14 13 12 11 10 9 8 7 6 5 4 3 2	1 0	
PFC stage status (1 = operative ; 0 = shutdown and fault)		
High temperature status (1 = presence and fault ; 0 = absence)		
AC line status (1 = absence and fault ; 0 = presence)		

Address 91: (1st PSM1250)		Secondary side fault information
Address 113: (2nd PSM1250)		
Address 179: (5th PSM1250)		
Address 201: (6th PSM1250)		
High Byte		Low Byte
Bit position		
15 14 13 12 11 10 9 8 7 6 5 4 3 2	1 0	
Over Voltage fault (1 = presence ; 0 = absence)		
Under Voltage fault (1 = presence ; 0 = absence)		
PWM stage status (1 = operative ; 0 = shutdown and fault)		

Address 92: (1st PSM1250)		Secondary side extra fault information
Address 114: (2nd PSM1250)		
Address 180: (5th PSM1250)		
Address 202: (6th PSM1250)		
High Byte		Low Byte
Bit position		
15 14 13 12 11 10 9 8 7 6 5 4 3 2	1 0	
Inter-modules protocol comm. fault from PSO1250 (1=fault; 0=ok)		
Intra-module protocol communication fault (1=fault; 0=ok)		
Fan B fault (1=fault, change > 5000 rpm on driver speed; 0=ok)		
Fan A fault (1=fault, change > 5000 rpm on driver speed; 0=ok)		

Address 209: (1st PSM1250)		Current Sharing group (CSg) with x pos. PSM1250
Address 210: (2nd PSM1250)		
Address 213: (5th PSM1250)		
Address 214: (6th PSM1250)		
High Byte		Low Byte
Bit position		
15 14 13 12 11 10 9 8 7 6	5 4 3 2 1 0	
All bits '0'		
6th PSM1250 (1 = belong ; 0 = not belong to CSg of x pos. PSM1250)		
5th PSM1250 (1 = belong ; 0 = not belong to CSg of x pos. PSM1250)		
2nd PSM1250 (1 = belong ; 0 = not belong to CSg of x pos. PSM1250)		
1st PSM1250 (1 = belong ; 0 = not belong to CSg of x pos. PSM1250)		

Address 464: Various commands	
High Byte	Low Byte
Bit position	
15 14 13 12 11 10 9 8 7 6 5 4 3 2 1 0	
1	Save Input/Output Configuration
2	Save Modbus configuration
8	Save Tags
9	Lock Alarms
10	Analog Output Sink/Source Switch

Address 517: Inter-modules missed communication	
High Byte	Low Byte
Bit position	
15 14 13 12 11 10 9 8 7 6 5 4 3 2 1 0	
All bits '0'	
6th position PSM1250 module (1=missed; 0=present)	
5th position PSM1250 module (1=missed; 0=present)	
2nd position PSM1250 module (1=missed; 0=present)	
1st position PSM1250 module (1=missed; 0=present)	

Address 533: Common fault status	
High Byte	Low Byte
Bit position	
15 14 13 12 11 10 9 8 7 6 5 4 3 2 1 0	
All bits '0'	
6th position PSM1250 module (1=fault ; 0=ok)	
5th position PSM1250 module (1=fault ; 0=ok)	
2nd position PSM1250 module (1=fault ; 0=ok)	
1st position PSM1250 module (1=fault ; 0=ok)	